

GARANZIA 5 ANNI  
GUARANTEE 5 YEARS  
GARANTIE 5 ANS  
GARANTIE 5 JAHRE  
GARANTIA 5 AÑOS



caleido®  
design radiators



Design by James Di Marco

# flora collection

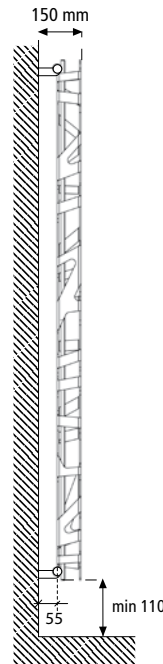
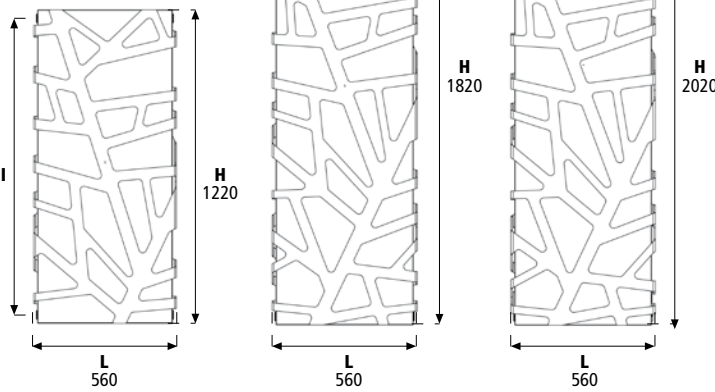
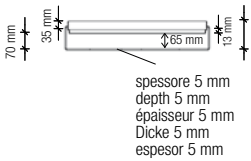

Interasse dal centro foro al muro 55 mm.  
Distance between hole center and wall 55 mm.  
Distance du centre du trou au mur 55 mm.  
Abstand zwischen Lochsmitte und Wand 55 mm.  
Distancia entre el centro del agujero y el muro 55 mm.

**I radiatori sono completi di kit di fissaggio a parete e valvola di sfiato.**  
Pressione di collaudo: 5,2 bar - Pressione di esercizio: 4 bar.  
Materiale: acciaio al carbonio + metacrilato.

The radiators are equipped with a kit for fixing them to the wall and with an exhaust valve.  
Testing pressure: 5,2 bar - Working pressure: 4 bar. Material: carbon steel + Acrylic.

Les radiateurs sont munis d'un kit de fixation murale et d'une soupape de décompression.  
Pression d'essai: 5,2 bars - Pression d'exercice: 4 bars. Matière: Acier au charbon + Acrylic.

Die Heizkörper sind mit Wandbefestigungsset und Luftventil ausgerüstet.  
Prüfungsdruck: 5,2 bar Betriebsdruck: 4 bar. Stoff: Kohlenstoffstahl + Acrylic.

Los radiadores están provistos de kit de fijación a la pared y de válvula de desahogo.  
Presión de ensayo: 5,2 bar - Presión de trabajo: 4 bar. Material: Acero de carbono + Acrylic.



Flora disponibile anche in versione solo elettrica o mista, consultare il listino radiatori elettrici.  
Flora available also in electric version or dual energy version, please see our electric radiators price list.  
Flora disponible dans la version seulement électrique ou dans la version mixte, voir le tarif radiateurs électriques.  
Flora in elektrischer Ausführung oder in gemischter Ausführung verfügbar, bitte sehen Sie die elektrische Heizkörper-Preisliste.  
Flora puede ser instalado también en versión solo eléctrica o en versión mixta consultar el listino de precios Versión eléctrica.

Interasse Centrale 50 mm **a richiesta.**  
Central distance between centers 50 mm **on request.**  
Entraxe centrale 50 mm **sur demande.**  
Mitteanschluss 50 mm **Auf Anfrage.**  
Distancia entre centros de 50 mm, **bajo pedido.**

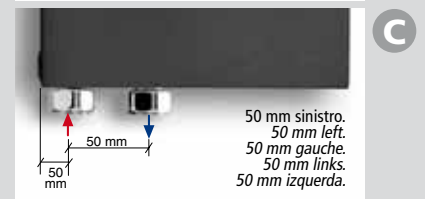
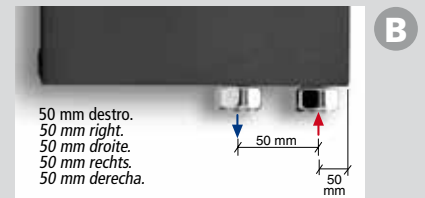
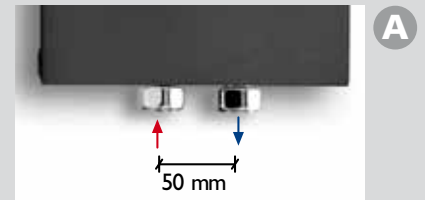

Allacciamento dal basso **a richiesta.**  
Bottom connection **on request.**  
Branchement par dessous **sur demande.**  
Anschluss von unten **Auf Anfrage.**  
Conexión por abajo **bajo pedido.**

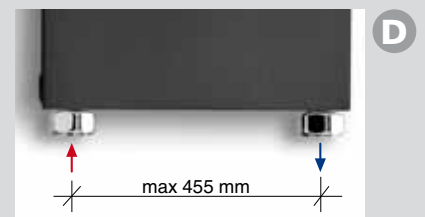

Allacciamenti possibili.  
Possible connections.  
Branchements possibles.  
Mögliche Anschlüsse.  
Empalmes standard.

**A richiesta**, il modello Flora può essere previsto per il montaggio in orizzontale con maggiorazione del 7%  
**On request** Flora can be produced for being mounting horizontally with 7% price surcharge  
**Sur demande** Flora peut être prévu pour l'installation en horizontal avec majoration du prix du 7%  
**Auf Anfrage** kann Flora gefertigt werden, um es horizontal zu montieren. Mehrpreis von 7%.  
**Bajo pedido** el modelo Flora puede ser previsto por el montaje en horizontal con aumento de 7%.

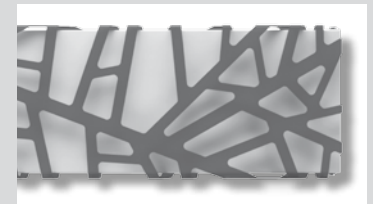

# flora COMBINATION 1

ice bianco + metacrilato arancio



## ICE

colore	colour	couleur	Farbe	color
bianco puro opaco RAL 9010	pure white matt RAL 9010	blanc pur mat RAL 9010	mattes reines Weiß RAL 9010	blanco puro mate RAL 9010

## Metacrilato / Acryl

colore	colour	couleur	Farbe	color
arancio	orange	orange	orange	anaranjado

$$\text{Watt} = \text{Kcal/h} \div 0,860$$

$$\text{Kcal/h} = \text{Watt} \times 0,860$$

codice code code Kode codigo	altezza height hauteur hoehe altura	larghezza width breite largeur longitud	interasse distance between bars entraxe achsabstand centros	peso weight poids gewicht peso	output 75/65-20 watt	output 55/45-20 watt	output 55/45-24 watt
	H mm	L mm	I mm	kg	Δt50	Δt30	Δt26
FFL125301	1220	560	1160	25	608	320	268
FFL185301	1820	560	1760	38	839	442	369
FFL205301	2020	560	1960	43	903	473	394

La tonalità di colore del metacrilato è indicativa.

*The Acrylic color hue may change slightly.*

*La tonalité de la couleur du Acrylic est indicative.*

*Der Acrylic Farbton ist richtungsweisend.*

*La tonalidad del color del Acrylic es indicativa.*

# flora COMBINATION 2

ice satinato + metacrilato arancio



## ICE

colore	colour	couleur	Farbe	color
satinato	satinated	satiné	satiniert	satinado

## Metacrilato / Acryl

colore	colour	couleur	Farbe	color
arancio	orange	orange	orange	anaranjado

$$\text{Watt} = \text{Kcal/h} \div 0,860$$

$$\text{Kcal/h} = \text{Watt} \times 0,860$$

codice code code Kode codigo	altezza height hauteur hoehe altura	larghezza width breite largeur longitud	interasse distance between bars entraxe achsabstand centros	peso weight poids gewicht peso	output 75/65-20 watt	output 55/45-20 watt	output 55/45-24 watt
	H mm	L mm	I mm	kg	Δt50	Δt30	Δt26
FFL125302	1220	560	1160	25	608	320	268
FFL185302	1820	560	1760	38	839	442	369
FFL205302	2020	560	1960	43	903	473	394

La tonalità di colore del metacrilato è indicativa.

*The Acrylic color hue may change slightly.*

*La tonalité de la couleur du Acrylic est indicative.*

*Der Acrylic Farbton ist richtungsweisend.*

*La tonalidad del color del Acrylic es indicativa.*



# flora COMBINATION 3

ice bianco + metacrilato rosso

EN <sup>\*\*\*</sup>442 EURONORM

## ICE

colore	colour	couleur	Farbe	color
bianco puro opaco RAL 9010	pure white matt RAL 9010	blanc pur mat RAL 9010	mattes reines Weiß RAL 9010	blanco puro mate RAL 9010

## Metacrilato / Acryl

colore	colour	couleur	Farbe	color
rosso	red	rouge	rot	rojo

$$\text{Watt} = \text{Kcal/h} \div 0,860$$

$$\text{Kcal/h} = \text{Watt} \times 0,860$$

codice code code code code code code	altezza height hauteur hoehe altura	larghezza width breite largeur longitud	interasse distance between bars entraxe achsabstand centros	peso weight poids gewicht peso	output 75/65-20 watt	output 55/45-20 watt	output 55/45-24 watt
	H mm	L mm	I mm	kg	Δt50	Δt30	Δt26
FFL125303	1220	560	1160	25	608	320	268
FFL185303	1820	560	1760	38	839	442	369
FFL205303	2020	560	1960	43	903	473	394

La tonalità di colore del metacrilato è indicativa.

*The Acrylic color hue may change slightly.*

*La tonalité de la couleur du Acrylic est indicative.*

*Der Acrylic Farbton ist richtungsweisend.*

*La tonalidad del color del Acrylic es indicativa.*



# flora COMBINATION 4

ice satinato + metacrilato rosso

EN <sup>\*\*\*</sup>442 EURONORM

## ICE

colore	colour	couleur	Farbe	color
satinato	satinated	satiné	satiniert	satinado

## Metacrilato / Acryl

colore	colour	couleur	Farbe	color
rosso	red	rouge	rot	rojo

$$\text{Watt} = \text{Kcal/h} \div 0,860$$

$$\text{Kcal/h} = \text{Watt} \times 0,860$$

codice code code code code code code	altezza height hauteur hoehe altura	larghezza width breite largeur longitud	interasse distance between bars entraxe achsabstand centros	peso weight poids gewicht peso	output 75/65-20 watt	output 55/45-20 watt	output 55/45-24 watt
	H mm	L mm	I mm	kg	Δt50	Δt30	Δt26
FFL125304	1220	560	1160	25	608	320	268
FFL185304	1820	560	1760	38	893	442	369
FFL205304	2020	560	1960	43	903	473	394

La tonalità di colore del metacrilato è indicativa.

*The Acrylic color hue may change slightly.*

*La tonalité de la couleur du Acrylic est indicative.*

*Der Acrylic Farbton ist richtungsweisend.*

*La tonalidad del color del Acrylic es indicativa.*



# flora COMBINATION 5

ice nero + metacrilato neutro trasparente



## ICE

colore	colour	couleur	Farbe	color
nero puro opaco RAL 9005	pure black matt RAL 9005	noir pur mat RAL 9005	mattes reines schwarz RAL 9005	negro puro mate RAL 9005

## Metacrilato / Acryl

colore	colour	couleur	Farbe	color
neutro trasparente	neutral transparent	neutre transparente	transparent	neutro trasparente

$$\text{Watt} = \text{Kcal/h} \div 0,860$$

$$\text{Kcal/h} = \text{Watt} \times 0,860$$

codice code code Kode codigo	altezza height hauteur hoehe altura	larghezza width breite largeur longitud	interasse distance between bars entraxe achsabstand centros	peso weight poids gewicht peso	output 75/65-20 watt	output 55/45-20 watt	output 55/45-24 watt
	H mm	L mm	I mm	kg	Δt50	Δt30	Δt26
FFL125305	1220	560	1160	25	608	320	268
FFL185305	1820	560	1760	38	839	442	369
FFL205305	2020	560	1960	43	903	473	394

La tonalità di colore del metacrilato è indicativa.

*The Acrylic color hue may change slightly.*

*La tonalité de la couleur du Acrylic est indicative.*

*Der Acrylic Farbton ist richtungsweisend.*

*La tonalidad del color del Acrylic es indicativa.*



# flora COMBINATION 6

ice satinato + metacrilato neutro trasparente



## ICE

colore	colour	couleur	Farbe	color
satinato	satinated	satiné	satiniert	satinado

## Metacrilato / Acryl

colore	colour	couleur	Farbe	color
neutro trasparente	neutral transparent	neutre transparente	transparent	neutro trasparente

$$\text{Watt} = \text{Kcal/h} \div 0,860$$

$$\text{Kcal/h} = \text{Watt} \times 0,860$$

codice code code Kode codigo	altezza height hauteur hoehe altura	larghezza width breite largeur longitud	interasse distance between bars entraxe achsabstand centros	peso weight poids gewicht peso	output 75/65-20 watt	output 55/45-20 watt	output 55/45-24 watt
	H mm	L mm	I mm	kg	Δt50	Δt30	Δt26
FFL125306	1220	560	1160	25	608	320	268
FFL185306	1820	560	1760	38	839	442	369
FFL205306	2020	560	1960	43	903	473	394

La tonalità di colore del metacrilato è indicativa.

*The Acrylic color hue may change slightly.*

*La tonalité de la couleur du Acrylic est indicative.*

*Der Acrylic Farbton ist richtungsweisend.*

*La tonalidad del color del Acrylic es indicativa.*

# flora COMBINATION 7

ice bianco + metacrilato nero



## ICE

colore	colour	couleur	Farbe	color
bianco puro opaco RAL 9010	pure white matt RAL 9010	blanc pur mat RAL 9010	mattes reines Weiß RAL 9010	blanco puro mate RAL 9010

## Metacrilato / Acryl

colore	colour	couleur	Farbe	color
nero	black	noir	schwarz	negro

$$\text{Watt} = \text{Kcal/h} \div 0,860$$

$$\text{Kcal/h} = \text{Watt} \times 0,860$$

codice code code Code codigo	altezza height hauteur hoehe altura	larghezza width breite largeur longitud	interasse distance between bars entraxe achsabstand centros	peso weight poids gewicht peso	output 75/65-20 watt	output 55/45-20 watt	output 55/45-24 watt
	H mm	L mm	I mm	kg	Δt50	Δt30	Δt26
FFL125307	1220	560	1160	25	608	320	268
FFL185307	1820	560	1760	38	839	442	369
FFL205307	2020	560	1960	43	903	473	394

La tonalità di colore del metacrilato è indicativa.

*The Acrylic color hue may change slightly.*

*La tonalité de la couleur du Acrylic est indicative.*

*Der Acrylic Farbton ist richtungsweisend.*

*La tonalidad del color del Acrylic es indicativa.*

# flora COMBINATION 8

ice satinato + metacrilato nero



## ICE

colore	colour	couleur	Farbe	color
satinato	satinated	satiné	satiniert	satinado

## Metacrilato / Acryl

colore	colour	couleur	Farbe	color
nero	black	noir	schwarz	negro

$$\text{Watt} = \text{Kcal/h} \div 0,860$$

$$\text{Kcal/h} = \text{Watt} \times 0,860$$

codice code code Code codigo	altezza height hauteur hoehe altura	larghezza width breite largeur longitud	interasse distance between bars entraxe achsabstand centros	peso weight poids gewicht peso	output 75/65-20 watt	output 55/45-20 watt	output 55/45-24 watt
	H mm	L mm	I mm	kg	Δt50	Δt30	Δt26
FFL125308	1220	560	1160	25	608	320	268
FFL185308	1820	560	1760	38	839	442	369
FFL205308	2020	560	1960	43	903	473	394

La tonalità di colore del metacrilato è indicativa.

*The Acrylic color hue may change slightly.*

*La tonalité de la couleur du Acrylic est indicative.*

*Der Acrylic Farbton ist richtungsweisend.*

*La tonalidad del color del Acrylic es indicativa.*

# flora COMBINATION 9

ice bianco + metacrilato verde

EN 442

## ICE

colore	colour	couleur	Farbe	color
bianco puro opaco RAL 9010	pure white matt RAL 9010	blanc pur mat RAL 9010	mattes reines Weiß RAL 9010	blanco puro mate RAL 9010

## Metacrilato / Acryl

colore	colour	couleur	Farbe	color
verde	green	vert	grün	verde

$$\text{Watt} = \text{Kcal/h} \div 0,860$$

$$\text{Kcal/h} = \text{Watt} \times 0,860$$

codice code code Kode codigo	altezza height hauteur hoehe altura	larghezza width breite largeur longitud	interasse distance between bars entraxe achsabstand centros	peso weight poids gewicht peso	output 75/65-20 watt	output 55/45-20 watt	output 55/45-24 watt
	H mm	L mm	I mm	kg	$\Delta t_{50}$	$\Delta t_{30}$	$\Delta t_{26}$
FFL125309	1220	560	1160	25	608	320	268
FFL185309	1820	560	1760	38	839	442	369
FFL205309	2020	560	1960	43	903	473	394

La tonalità di colore del metacrilato è indicativa.

*The Acrylic color hue may change slightly.*

*La tonalité de la couleur du Acrylic est indicative.*

*Der Acrylic Farbton ist richtungsweisend.*

*La tonalidad del color del Acrylic es indicativa.*

# flora COMBINATION 10

ice nero + metacrilato verde

EN 442

## ICE

colore	colour	couleur	Farbe	color
nero puro opaco RAL 9005	pure black matt RAL 9005	noir pur mat RAL 9005	mattes reines schwarz RAL 9005	negro puro mate RAL 9005

## Metacrilato / Acryl

colore	colour	couleur	Farbe	color
verde	green	vert	grün	verde

$$\text{Watt} = \text{Kcal/h} \div 0,860$$

$$\text{Kcal/h} = \text{Watt} \times 0,860$$

codice code code Kode codigo	altezza height hauteur hoehe altura	larghezza width breite largeur longitud	interasse distance between bars entraxe achsabstand centros	peso weight poids gewicht peso	output 75/65-20 watt	output 55/45-20 watt	output 55/45-24 watt
	H mm	L mm	I mm	kg	$\Delta t_{50}$	$\Delta t_{30}$	$\Delta t_{26}$
FFL125310	1220	560	1160	25	608	320	268
FFL185310	1820	560	1760	38	442	442	369
FFL205310	2020	560	1960	43	903	473	394

La tonalità di colore del metacrilato è indicativa.

*The Acrylic color hue may change slightly.*

*La tonalité de la couleur du Acrylic est indicative.*

*Der Acrylic Farbton ist richtungsweisend.*

*La tonalidad del color del Acrylic es indicativa.*



# flora COMBINATION 11

ice bianco + metacrilato azzurro



## ICE

colore	colour	couleur	Farbe	color
bianco puro opaco RAL 9010	pure white matt RAL 9010	blanc pur mat RAL 9010	mattes reines Weiß RAL 9010	blanco puro mate RAL 9010

## Metacrilato / Acryl

colore	colour	couleur	Farbe	color
azzurro	light blue	azuré	blau	azul

$$\text{Watt} = \text{Kcal/h} \div 0,860$$

$$\text{Kcal/h} = \text{Watt} \times 0,860$$

codice code code code code codigo	altezza height hauteur hoehe altura	larghezza width breite largeur longitud	interasse distance between bars entraxe achsabstand centros	peso weight poids gewicht peso	output 75/65-20 watt	output 55/45-20 watt	output 55/45-24 watt
	H mm	L mm	I mm	kg	Δt50	Δt30	Δt26
FFL125311	1220	560	1160	25	608	320	268
FFL185311	1820	560	1760	38	839	442	369
FFL205311	2020	560	1960	43	903	473	394

Δt50

La tonalità di colore del metacrilato è indicativa.

*The Acrylic color hue may change slightly.*

*La tonalité de la couleur du Acrylic est indicative.*

*Der Acrylic Farbton ist richtungsweisend.*

*La tonalidad del color del Acrylic es indicativa.*



# flora COMBINATION 12

ice nero + metacrilato azzurro



## ICE

colore	colour	couleur	Farbe	color
nero puro opaco RAL 9005	pure black matt RAL 9005	noir pur mat RAL 9005	mattes reines schwarz RAL 9005	negro puro mate RAL 9005

## Metacrilato / Acryl

colore	colour	couleur	Farbe	color
azzurro	light blue	azuré	blau	azul

$$\text{Watt} = \text{Kcal/h} \div 0,860$$

$$\text{Kcal/h} = \text{Watt} \times 0,860$$

codice code code code code codigo	altezza height hauteur hoehe altura	larghezza width breite largeur longitud	interasse distance between bars entraxe achsabstand centros	peso weight poids gewicht peso	output 75/65-20 watt	output 55/45-20 watt	output 55/45-24 watt
	H mm	L mm	I mm	kg	Δt50	Δt30	Δt26
FFL125312	1220	560	1160	25	608	320	268
FFL185312	1820	560	1760	38	839	442	369
FFL205312	2020	560	1960	43	903	473	394

La tonalità di colore del metacrilato è indicativa.

*The Acrylic color hue may change slightly.*

*La tonalité de la couleur du Acrylic est indicative.*

*Der Acrylic Farbton ist richtungsweisend.*

*La tonalidad del color del Acrylic es indicativa.*



GARANZIA 5 ANNI  
GUARANTEE 5 YEARS  
GARANTIE 5 ANS  
GARANTIE 5 JAHRE  
GARANTÍA 5 AÑOS



caleido®  
design radiators



Design by James Di Marco

# rain collection

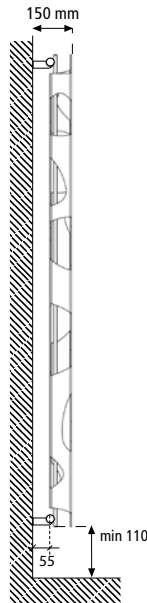
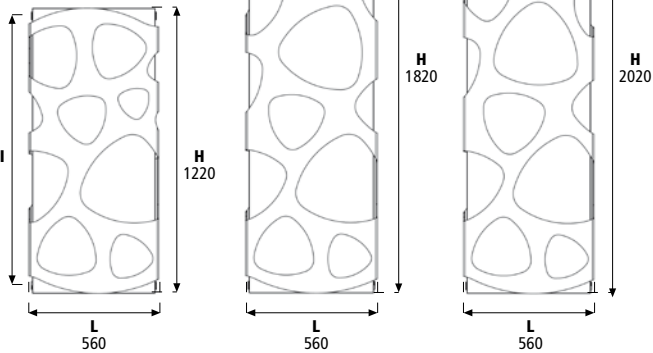
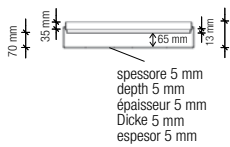

Interasse dal centro foro al muro 55 mm.  
Distance between hole center and wall 55 mm.  
Distance du centre du trou au mur 55 mm.  
Abstand zwischen Lochmitte und Wand 55 mm.  
Distancia entre el centro del agujero y el muro 55 mm.

**I radiatori sono completi di kit di fissaggio a parete e valvola di sfiato.**  
Pressione di collaudo: 5,2 bar - Pressione di esercizio: 4 bar.  
Materiale: acciaio al carbonio + metacrilato.

The radiators are equipped with a kit for fixing them to the wall and with an exhaust valve.  
Testing pressure: 5,2 bar - Working pressure: 4 bar. Material: carbon steel + Acrylic.

Les radiateurs sont munis d'un kit de fixation murale et d'une soupape de décompression.  
Pression d'essai: 5,2 bars - Pression d'exercice: 4 bars. Matière: Acier au charbon + Acrylic.

Die Heizkörper sind mit Wandbefestigungsset und Luftventil ausgerüstet.  
Prüfungsdruck: 5,2 bar Betriebsdruck: 4 bar. Stoff: Kohlenstoffstahl + Acrylic.

Los radiadores están provistos de kit de fijación a la pared y de válvula de desahogo.  
Presión de ensayo: 5,2 bar - Presión de trabajo: 4 bar. Material: Acero de carbono + Acrylic.



Rain disponibile anche in versione solo elettrica o mista, consultare il listino radiatori elettrici.  
Rain available also in electric version or dual energy version, please see our electric radiators price list.  
Rain disponible dans la version seulement électrique ou dans la version mixte, voir le tarif radiateurs électriques.  
Rain in elektrischer Ausführung oder in gemischter Ausführung verfügbar, bitte sehen Sie die elektrische Heizkörper-Preisliste.  
Rain puede ser instalado también en versión solo eléctrica o en versión mixta consultar el listino de precios Versión eléctrica.

Interasse Centrale 50 mm a richiesta.  
Central distance between centers 50 mm on request.  
Entraxe centrale 50 mm sur demande.  
Mitteanschluss 50 mm Auf Anfrage.  
Distancia entre centros de 50 mm, bajo pedido.

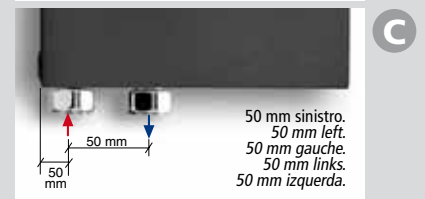
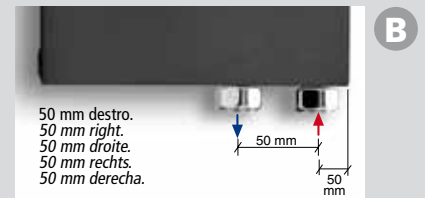
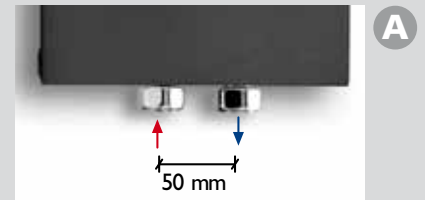

Allacciamento dal basso a richiesta.  
Bottom connection on request.  
Branchement par dessous sur demande.  
Anschluss von unten Auf Anfrage.  
Conexión por abajo bajo pedido.

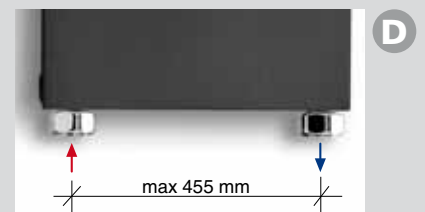

Allacciamenti possibili.  
Possible connections.  
Branchements possibles.  
Mögliche Anschlüsse.  
Empalmes standard.

A richiesta, il modello Rain può essere previsto per il montaggio in orizzontale con maggiorazione del 7%  
On request Rain can be produced for being mounting horizontally with 7% price surcharge  
Sur demande Rain peut être prévu pour l'installation en horizontal avec majoration du prix du 7%  
Auf Anfrage kann Rain gefertigt werden, um es horizontal zu montieren. Mehrpreis von 7%.  
Bajo pedido el modelo Rain puede ser previsto por el montaje en horizontal con aumento de 7%.

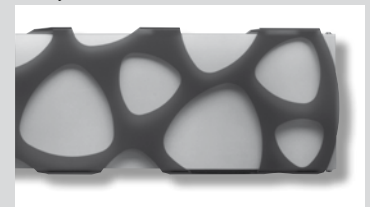

# rain COMBINATION 37

ice bianco + metacrilato arancio

\*\*\* Euronorm  
**EN 442**

## ICE

colore	colour	couleur	Farbe	color
bianco puro opaco RAL 9010	pure white matt RAL 9010	blanc pur mat RAL 9010	mattes reines Weiß RAL 9010	blanco puro mate RAL 9010

## Metacrilato / Acryl

colore	colour	couleur	Farbe	color
arancio	orange	orange	orange	anaranjado

$$\text{Watt} = \text{Kcal/h} \div 0,860$$

$$\text{Kcal/h} = \text{Watt} \times 0,860$$

codice code code Kode codigo	altezza height hauteur hoehe altura	larghezza width breite largeur longitud	interasse distance between bars entraxe achsabstand centros	peso weight poids gewicht peso	output watt	output watt	output watt
	H mm	L mm	I mm	kg	Δt50	Δt30	Δt26
FDR125337	1220	560	1160	25	608	320	268
FDR185337	1820	560	1760	38	839	442	369
FDR205337	2020	560	1960	43	903	473	394

La tonalità di colore del metacrilato è indicativa.

*The Acrylic color hue may change slightly.*

*La tonalité de la couleur du Acrylic est indicative.*

*Der Acrylic Farbton ist richtungsweisend.*

*La tonalidad del color del Acrylic es indicativa.*

# rain COMBINATION 38

ice satinato + metacrilato arancio

\*\*\* Euronorm  
**EN 442**

## ICE

colore	colour	couleur	Farbe	color
satinato	satinated	satiné	satiniert	satinado

## Metacrilato / Acryl

colore	colour	couleur	Farbe	color
arancio	orange	orange	orange	anaranjado

$$\text{Watt} = \text{Kcal/h} \div 0,860$$

$$\text{Kcal/h} = \text{Watt} \times 0,860$$

codice code code Kode codigo	altezza height hauteur hoehe altura	larghezza width breite largeur longitud	interasse distance between bars entraxe achsabstand centros	peso weight poids gewicht peso	output watt	output watt	output watt
	H mm	L mm	I mm	kg	Δt50	Δt30	Δt26
FDR125338	1220	560	1160	25	608	320	268
FDR185338	1820	560	1760	38	839	442	369
FDR205338	2020	560	1960	43	903	473	394

La tonalità di colore del metacrilato è indicativa.

*The Acrylic color hue may change slightly.*

*La tonalité de la couleur du Acrylic est indicative.*

*Der Acrylic Farbton ist richtungsweisend.*

*La tonalidad del color del Acrylic es indicativa.*

# rain COMBINATION 39

ice bianco + metacrilato rosso

EN 442

## ICE

colore	colour	couleur	Farbe	color
bianco puro opaco RAL 9010	pure white matt RAL 9010	blanc pur mat RAL 9010	mattes reines Weiß RAL 9010	blanco puro mate RAL 9010

## Metacrilato / Acryl

colore	colour	couleur	Farbe	color
rosso	red	rouge	rot	rojo

codice code code Kode codigo	altezza height hauteur hoehe altura	larghezza width breite largeur longitud	interasse distance between bars entraxe achsabstand centros	peso weight poids gewicht peso	output 75/65-20 watt	output 75/65-20 watt	output 55/45-24 watt
	H mm	L mm	I mm	kg	Δt50	Δt30	Δt26
FDR125339	1220	560	1160	25	608	320	268
FDR185339	1820	560	1760	38	839	442	369
FDR205339	2020	560	1960	43	903	473	394

La tonalità di colore del metacrilato è indicativa.

*The Acrylic color hue may change slightly.*

*La tonalité de la couleur du Acrylic est indicative.*

*Der Acrylic Farbton ist richtungsweisend.*

*La tonalidad del color del Acrylic es indicativa.*

# rain COMBINATION 40

ice satinato + metacrilato rosso

EN 442

## ICE

colore	colour	couleur	Farbe	color
satinato	satinated	satiné	satiniert	satinado

## Metacrilato / Acryl

colore	colour	couleur	Farbe	color
rosso	red	rouge	rot	rojo

codice code code Kode codigo	altezza height hauteur hoehe altura	larghezza width breite largeur longitud	interasse distance between bars entraxe achsabstand centros	peso weight poids gewicht peso	output 75/65-20 watt	output 75/65-20 watt	output 55/45-24 watt
	H mm	L mm	I mm	kg	Δt50	Δt30	Δt26
FDR125340	1220	560	1160	25	608	320	268
FDR185340	1820	560	1760	38	839	442	369
FDR205340	2020	560	1960	43	903	473	394

La tonalità di colore del metacrilato è indicativa.

*The Acrylic color hue may change slightly.*

*La tonalité de la couleur du Acrylic est indicative.*

*Der Acrylic Farbton ist richtungsweisend.*

*La tonalidad del color del Acrylic es indicativa.*



# rain COMBINATION 41

ice nero + metacrilato neutro trasparente



## ICE

colore	colour	couleur	Farbe	color
nero puro opaco RAL 9005	pure black matt RAL 9005	noir pur mat RAL 9005	mattes reines schwarz RAL 9005	negro puro mate RAL 9005

## Metacrilato / Acryl

colore	colour	couleur	Farbe	color
neutro trasparente	neutral transparent	neutre transparente	transparent	neutro trasparente

$$\text{Watt} = \text{Kcal/h} \div 0,860$$

$$\text{Kcal/h} = \text{Watt} \times 0,860$$

codice code code Kode codigo	altezza height hauteur hoehe altura	larghezza width breite largeur longitud	interasse distance between bars entraxe achsabstand centros	peso weight poids gewicht peso	output	output	output
					75/65-20 watt	75/65-20 watt	55/45-24 watt
	H mm	L mm	I mm	kg	Δt50	Δt30	Δt26
FDR125341	1220	560	1160	25	608	320	268
FDR185341	1820	560	1760	38	839	442	369
FDR205341	2020	560	1960	43	903	473	394

La tonalità di colore del metacrilato è indicativa.

*The Acrylic color hue may change slightly.*

*La tonalité de la couleur du Acrylic est indicative.*

*Der Acrylic Farbton ist richtungsweisend.*

*La tonalidad del color del Acrylic es indicativa.*



# rain COMBINATION 42

ice satinato + metacrilato neutro trasparente



## ICE

colore	colour	couleur	Farbe	color
satinato	satinated	satiné	satiniert	satinado

## Metacrilato / Acryl

colore	colour	couleur	Farbe	color
neutro trasparente	neutral transparent	neutre transparente	transparent	neutro trasparente

$$\text{Watt} = \text{Kcal/h} \div 0,860$$

$$\text{Kcal/h} = \text{Watt} \times 0,860$$

codice code code Kode codigo	altezza height hauteur hoehe altura	larghezza width breite largeur longitud	interasse distance between bars entraxe achsabstand centros	peso weight poids gewicht peso	output	output	output
					75/65-20 watt	75/65-20 watt	55/45-24 watt
	H mm	L mm	I mm	kg	Δt50	Δt30	Δt26
FDR125342	1220	560	1160	25	608	320	268
FDR185342	1820	560	1760	38	839	442	369
FDR205342	2020	560	1960	43	903	473	394

La tonalità di colore del metacrilato è indicativa.

*The Acrylic color hue may change slightly.*

*La tonalité de la couleur du Acrylic est indicative.*

*Der Acrylic Farbton ist richtungsweisend.*

*La tonalidad del color del Acrylic es indicativa.*

# rain COMBINATION 43

ice bianco + metacrilato nero

EN <sup>\*\*\*</sup>442 EURONORM

## ICE

colore	colour	couleur	Farbe	color
bianco puro opaco RAL 9010	pure white matt RAL 9010	blanc pur mat RAL 9010	mattes reines Weiß RAL 9010	blanco puro mate RAL 9010

## Metacrilato / Acryl

colore	colour	couleur	Farbe	color
nero	black	noir	schwarz	negro

codice code code Kode codigo	altezza height hauteur hoehe altura	larghezza width breite largeur longitud	interasse distance between bars entraxe achsabstand centros	peso weight poids gewicht peso	output	output	output
	H mm	L mm	I mm	kg	Δt50	Δt30	Δt26
FDR125343	1220	560	1160	25	608	320	268
FDR185343	1820	560	1760	38	839	442	369
FDR205343	2020	560	1960	43	903	473	394

La tonalità di colore del metacrilato è indicativa.

*The Acrylic color hue may change slightly.*

*La tonalité de la couleur du Acrylic est indicative.*

*Der Acrylic Farbton ist richtungsweisend.*

*La tonalidad del color del Acrylic es indicativa.*

# rain COMBINATION 44

ice satinato + metacrilato nero

EN <sup>\*\*\*</sup>442 EURONORM

## ICE

colore	colour	couleur	Farbe	color
satinato	satinated	satiné	satiniert	satinado

## Metacrilato / Acryl

colore	colour	couleur	Farbe	color
nero	black	noir	schwarz	negro

codice code code Kode codigo	altezza height hauteur hoehe altura	larghezza width breite largeur longitud	interasse distance between bars entraxe achsabstand centros	peso weight poids gewicht peso	output	output	output
	H mm	L mm	I mm	kg	Δt50	Δt30	Δt26
FDR125344	1220	560	1160	25	608	320	268
FDR185344	1820	560	1760	38	839	442	369
FDR205344	2020	560	1960	43	903	473	394

La tonalità di colore del metacrilato è indicativa.

*The Acrylic color hue may change slightly.*

*La tonalité de la couleur du Acrylic est indicative.*

*Der Acrylic Farbton ist richtungsweisend.*

*La tonalidad del color del Acrylic es indicativa.*



# rain COMBINATION 45

ice bianco + metacrilato verde



## ICE

colore	colour	couleur	Farbe	color
bianco puro opaco RAL 9010	pure white matt RAL 9010	blanc pur mat RAL 9010	mattes reines Weiß RAL 9010	blanco puro mate RAL 9010

## Metacrilato / Acryl

colore	colour	couleur	Farbe	color
verde	green	vert	grün	verde

$$\text{Watt} = \text{Kcal/h} \div 0,860$$

$$\text{Kcal/h} = \text{Watt} \times 0,860$$

codice code code Kode codigo	altezza height hauteur hoehe altura	larghezza width breite largeur longitud	interasse distance between bars entraxe achsabstand centros	peso weight poids gewicht peso	output	output	output
					75/65-20	75/65-20	55/45-24
	H mm	L mm	I mm	kg	watt	watt	watt
					$\Delta t50$	$\Delta t30$	$\Delta t26$
FDR125345	1220	560	1160	25	608	320	368
FDR185345	1820	560	1760	38	839	442	369
FDR205345	2020	560	1960	43	903	473	394

La tonalità di colore del metacrilato è indicativa.

*The Acrylic color hue may change slightly.*

*La tonalité de la couleur du Acrylic est indicative.*

*Der Acrylic Farbton ist richtungsweisend.*

*La tonalidad del color del Acrylic es indicativa.*



# rain COMBINATION 46

ice nero + metacrilato verde



## ICE

colore	colour	couleur	Farbe	color
nero puro opaco RAL 9005	pure black matt RAL 9005	noir pur mat RAL 9005	mattes reines schwarz RAL 9005	negro puro mate RAL 9005

## Metacrilato / Acryl

colore	colour	couleur	Farbe	color
verde	green	vert	grün	verde

$$\text{Watt} = \text{Kcal/h} \div 0,860$$

$$\text{Kcal/h} = \text{Watt} \times 0,860$$

codice code code Kode codigo	altezza height hauteur hoehe altura	larghezza width breite largeur longitud	interasse distance between bars entraxe achsabstand centros	peso weight poids gewicht peso	output	output	output
					75/65-20	75/65-20	55/45-24
	H mm	L mm	I mm	kg	watt	watt	watt
					$\Delta t50$	$\Delta t30$	$\Delta t26$
FDR125346	1220	560	1160	25	608	320	368
FDR185346	1820	560	1760	38	839	442	369
FDR205346	2020	560	1960	43	903	473	394

La tonalità di colore del metacrilato è indicativa.

*The Acrylic color hue may change slightly.*

*La tonalité de la couleur du Acrylic est indicative.*

*Der Acrylic Farbton ist richtungsweisend.*

*La tonalidad del color del Acrylic es indicativa.*



# rain COMBINATION 47

ice bianco + metacrilato azzurro



## ICE

colore	colour	couleur	Farbe	color
bianco puro opaco RAL 9010	pure white matt RAL 9010	blanc pur mat RAL 9010	mattes reines Weiß RAL 9010	blanco puro mate RAL 9010

## Metacrilato / Acryl

colore	colour	couleur	Farbe	color
azzurro	light blue	azuré	blau	azul

codice code code Kode codigo	altezza height hauteur hoehe altura	larghezza width breite largeur longitud	interasse distance between bars entraxe achsabstand centros	peso weight poids gewicht peso	output	output	output
	H mm	L mm	I mm	kg	Δt50	Δt30	Δt26
FDR125347	1220	560	1160	25	608	320	268
FDR185347	1820	560	1760	38	839	442	369
FDR205347	2020	560	1960	43	903	473	394

La tonalità di colore del metacrilato è indicativa.

*The Acrylic color hue may change slightly.*

*La tonalité de la couleur du Acrylic est indicative.*

*Der Acrylic Farbton ist richtungsweisend.*

*La tonalidad del color del Acrylic es indicativa.*



# rain COMBINATION 48

ice nero + metacrilato azzurro



## ICE

colore	colour	couleur	Farbe	color
nero puro opaco RAL 9005	pure black matt RAL 9005	noir pur mat RAL 9005	mattes reines schwarz RAL 9005	negro puro mate RAL 9005

## Metacrilato / Acryl

colore	colour	couleur	Farbe	color
azzurro	light blue	azuré	blau	azul

codice code code Kode codigo	altezza height hauteur hoehe altura	larghezza width breite largeur longitud	interasse distance between bars entraxe achsabstand centros	peso weight poids gewicht peso	output	output	output
	H mm	L mm	I mm	kg	Δt50	Δt30	Δt26
FDR125348	1220	560	1160	25	608	320	268
FDR185348	1820	560	1760	38	839	442	369
FDR205348	2020	560	1960	43	903	473	394

La tonalità di colore del metacrilato è indicativa.

*The Acrylic color hue may change slightly.*

*La tonalité de la couleur du Acrylic est indicative.*

*Der Acrylic Farbton ist richtungsweisend.*

*La tonalidad del color del Acrylic es indicativa.*



GARANZIA 5 ANNI  
GUARANTEE 5 YEARS  
GARANTIE 5 ANS  
GARANTIE 5 JAHRE  
GARANTÍA 5 AÑOS





Design by James Di Marco

# scuba collection

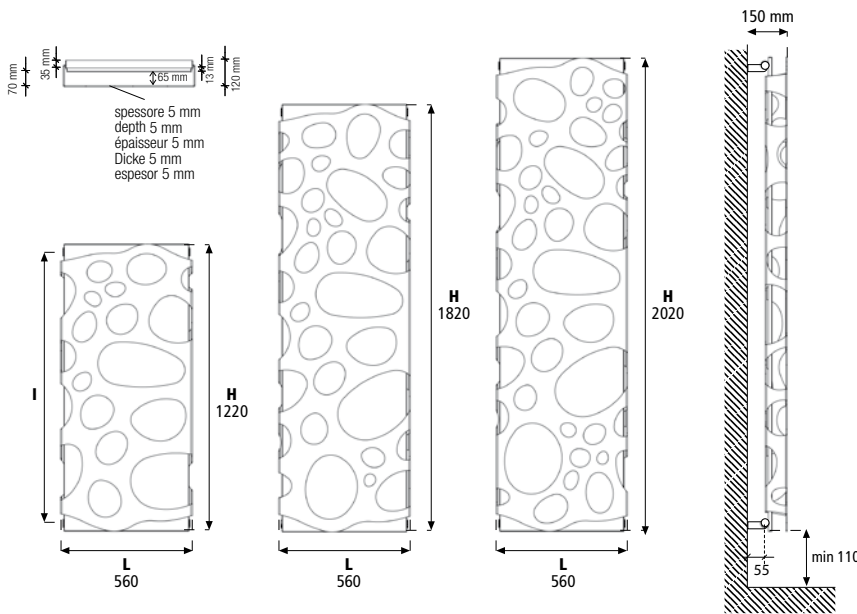

Interasse dal centro foro al muro 55 mm.  
 Distance between hole center and wall 55 mm.  
 Distance du centre du trou au mur 55 mm.  
 Abstand zwischen Lochmitte und Wand 55 mm.  
 Distancia entre el centro del agujero y el muro 55 mm.

**I radiatori sono completi di kit di fissaggio a parete e valvola di sfiato.**  
**Pressione di collaudo: 5,2 bar - Pressione di esercizio: 4 bar.**  
**Materiale: acciaio al carbonio + metacrilato.**

The radiators are equipped with a kit for fixing them to the wall and with an exhaust valve.  
 Testing pressure: 5,2 bar - Working pressure: 4 bar. Material: carbon steel + Acrylic.

Les radiateurs sont munis d'un kit de fixation murale et d'une soupape de décompression.  
 Pression d'essai: 5,2 bars - Pression d'exercice: 4 bars. Matière: Acier au charbon + Acrylic.

Die Heizkörper sind mit Wandbefestigungsset und Luftventil ausgerüstet.  
 Prüfungsdruck: 5,2 bar Betriebsdruck: 4 bar. Stoff: Kohlenstoffstahl + Acrylic.

Los radiadores están provistos de kit de fijación a la pared y de válvula de desahogo.  
 Presión de ensayo: 5,2 bar - Presión de trabajo: 4 bar. Material: Acero de carbono + Acrylic.



Scuba disponibile anche in **versione solo elettrica o mista**, consultare il **listino radiatori elettrici**.  
 Scuba available also in **electric version or dual energy version**, please see our **electric radiators price list**.  
 Scuba disponible dans la **version seulement électrique ou dans la version mixte**, voir le **tarif radiateurs électriques**.  
 Scuba in **elektrischer Ausführung oder in gemischter Ausführung** verfügbar, bitte sehen Sie die **elektrische Heizkörper-Preisliste**.  
 Scuba puede ser instalado también en **version solo eléctrica** o en **version mixta** consultar el **listin de precios Versión eléctrica**.

Interasse Centrale 50 mm **a richiesta**.  
 Central distance between centers 50 mm **on request**.  
 Entraxe centrale 50 mm **sur demande**.  
 Mitteanschluss 50 mm **Auf Anfrage**.  
 Distancia entre centros de 50 mm, **bajo pedido**.

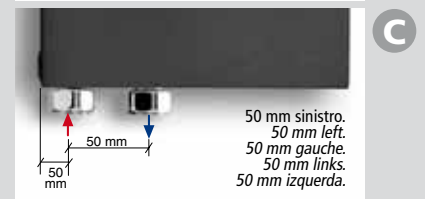
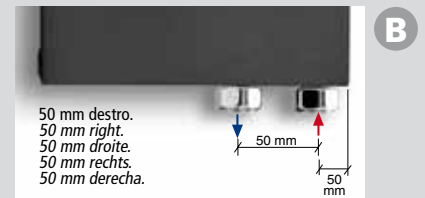
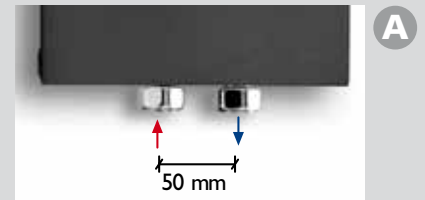

Allacciamento dal basso **a richiesta**.  
 Bottom connection **on request**.  
 Branchement par dessous **sur demande**.  
 Anschluss von unten **Auf Anfrage**.  
 Conexión por abajo **bajo pedido**.

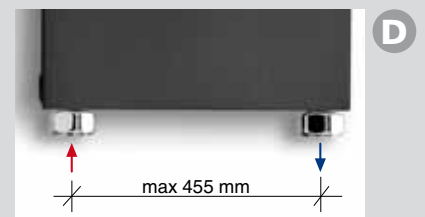

Allacciamenti possibili.  
 Possible connections.  
 Branchements possibles.  
 Mögliche Anschlüsse.  
 Empalmes standard.

**A richiesta**, il modello Scuba può essere previsto per il montaggio in orizzontale con maggiorazione del 7%  
**On request** Scuba can be produced for being mounting horizontally with 7% price surcharge  
**Sur demande** Scuba peut être prévu pour l'installation en horizontal avec majoration du prix du 7%  
**Auf Anfrage** kann Scuba gefertigt werden, um es horizontal zu montieren. Mehrpreis von 7%.  
**Bajo pedido** el modelo Scuba puede ser previsto por el montaje en horizontal con aumento de 7%.

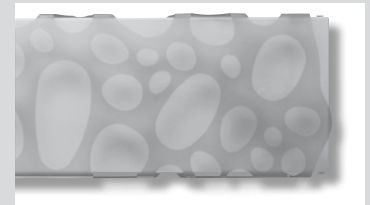

# scuba COMBINATION 13

ice bianco + metacrilato arancio

## ICE

colore	colour	couleur	Farbe	color
bianco puro opaco RAL 9010	pure white matt RAL 9010	blanc pur mat RAL 9010	mattes reines Weiß RAL 9010	blanco puro mate RAL 9010

## Metacrilato / Acryl

colore	colour	couleur	Farbe	color
arancio	orange	orange	orange	anaranjado

$$\text{Watt} = \text{Kcal/h} \div 0,860$$

$$\text{Kcal/h} = \text{Watt} \times 0,860$$

codice code code Kode codigo	altezza height hauteur hoehe altura	larghezza width breite largeur longitud	interasse distance between bars entraxe achsabstand centros	peso weight poids gewicht peso	output 75/65-20 watt	output 55/45-20 watt	output 55/45-24 watt
	H mm	L mm	I mm	kg	Δt50	Δt30	Δt26
FSC125313	1220	560	1160	25	608	320	268
FSC185313	1820	560	1760	38	839	442	369
FSC205313	2020	560	1960	43	903	473	394

La tonalità di colore del metacrilato è indicativa.

*The Acrylic color hue may change slightly.*

*La tonalité de la couleur du Acrylic est indicative.*

*Der Acrylic Farbton ist richtungsweisend.*

*La tonalidad del color del Acrylic es indicativa.*

# scuba COMBINATION 14

ice satinato + metacrilato arancio

## ICE

colore	colour	couleur	Farbe	color
satinato	satinated	satiné	satiniert	satinado

## Metacrilato / Acryl

colore	colour	couleur	Farbe	color
arancio	orange	orange	orange	anaranjado

$$\text{Watt} = \text{Kcal/h} \div 0,860$$

$$\text{Kcal/h} = \text{Watt} \times 0,860$$

codice code code Kode codigo	altezza height hauteur hoehe altura	larghezza width breite largeur longitud	interasse distance between bars entraxe achsabstand centros	peso weight poids gewicht peso	output 75/65-20 watt	output 55/45-20 watt	output 55/45-24 watt
	H mm	L mm	I mm	kg	Δt50	Δt30	Δt26
FSC125314	1220	560	1160	25	608	320	268
FSC185314	1820	560	1760	38	839	442	369
FSC205314	2020	560	1960	43	903	473	394

La tonalità di colore del metacrilato è indicativa.

*The Acrylic color hue may change slightly.*

*La tonalité de la couleur du Acrylic est indicative.*

*Der Acrylic Farbton ist richtungsweisend.*

*La tonalidad del color del Acrylic es indicativa.*

# scuba COMBINATION 15

ice bianco + metacrilato rosso

EN 442

## ICE

colore	colour	couleur	Farbe	color
bianco puro opaco RAL 9010	pure white matt RAL 9010	blanc pur mat RAL 9010	mattes reines Weiß RAL 9010	blanco puro mate RAL 9010

## Metacrilato / Acryl

colore	colour	couleur	Farbe	color
rosso	red	rouge	rot	rojo

$$\text{Watt} = \text{Kcal/h} \div 0,860$$

$$\text{Kcal/h} = \text{Watt} \times 0,860$$

codice code code Code codigo	altezza height hauteur hoehe altura	larghezza width breite largeur longitud	interasse distance between bars entraxe achsabstand centros	peso weight poids gewicht peso	output 75/65-20 watt	output 55/45-20 watt	output 55/45-24 watt
	H mm	L mm	I mm	kg	Δt50	Δt30	Δt26
FSC125315	1220	560	1160	25	608	320	268
FSC185315	1820	560	1760	38	839	442	369
FSC205315	2020	560	1960	43	903	473	394

La tonalità di colore del metacrilato è indicativa.

*The Acrylic color hue may change slightly.*

*La tonalité de la couleur du Acrylic est indicative.*

*Der Acrylic Farbton ist richtungsweisend.*

*La tonalidad del color del Acrylic es indicativa.*

# scuba COMBINATION 16

ice satinato + metacrilato rosso

EN 442

## ICE

colore	colour	couleur	Farbe	color
satinato	satinated	satiné	satiniert	satinado

## Metacrilato / Acryl

colore	colour	couleur	Farbe	color
rosso	red	rouge	rot	rojo

$$\text{Watt} = \text{Kcal/h} \div 0,860$$

$$\text{Kcal/h} = \text{Watt} \times 0,860$$

codice code code Code codigo	altezza height hauteur hoehe altura	larghezza width breite largeur longitud	interasse distance between bars entraxe achsabstand centros	peso weight poids gewicht peso	output 75/65-20 watt	output 55/45-20 watt	output 55/45-24 watt
	H mm	L mm	I mm	kg	Δt50	Δt30	Δt26
FSC125316	1220	560	1160	25	608	320	268
FSC185316	1820	560	1760	38	839	442	369
FSC205316	2020	560	1960	43	903	473	394

La tonalità di colore del metacrilato è indicativa.

*The Acrylic color hue may change slightly.*

*La tonalité de la couleur du Acrylic est indicative.*

*Der Acrylic Farbton ist richtungsweisend.*

*La tonalidad del color del Acrylic es indicativa.*



# scuba COMBINATION 17

ice nero + metacrilato neutro trasparente



## ICE

colore	colour	couleur	Farbe	color
nero puro opaco RAL 9005	pure black matt RAL 9005	noir pur mat RAL 9005	mattes reines schwarz RAL 9005	negro puro mate RAL 9005

## Metacrilato / Acryl

colore	colour	couleur	Farbe	color
neutro trasparente	neutral transparent	neutre transparente	transparent	neutro trasparente

$$\text{Watt} = \text{Kcal/h} \div 0,860$$

$$\text{Kcal/h} = \text{Watt} \times 0,860$$

codice code code Kode codigo	altezza height hauteur hoehe altura	larghezza width breite largeur longitud	interasse distance between bars entraxe achsabstand centros	peso weight poids gewicht peso	output 75/65-20 watt	output 55/45-20 watt	output 55/45-24 watt
	H mm	L mm	I mm	kg	Δt50	Δt30	Δt26
FSC125317	1220	560	1160	25	608	320	268
FSC185317	1820	560	1760	38	839	442	369
FSC205317	2020	560	1960	43	903	473	394

La tonalità di colore del metacrilato è indicativa.

*The Acrylic color hue may change slightly.*

*La tonalité de la couleur du Acrylic est indicative.*

*Der Acrylic Farbton ist richtungsweisend.*

*La tonalidad del color del Acrylic es indicativa.*



# scuba COMBINATION 18

ice satinato + metacrilato neutro trasparente



## ICE

colore	colour	couleur	Farbe	color
satinato	satinated	satiné	satiniert	satinado

## Metacrilato / Acryl

colore	colour	couleur	Farbe	color
neutro trasparente	neutral transparent	neutre transparente	transparent	neutro trasparente

$$\text{Watt} = \text{Kcal/h} \div 0,860$$

$$\text{Kcal/h} = \text{Watt} \times 0,860$$

codice code code Kode codigo	altezza height hauteur hoehe altura	larghezza width breite largeur longitud	interasse distance between bars entraxe achsabstand centros	peso weight poids gewicht peso	output 75/65-20 watt	output 55/45-20 watt	output 55/45-24 watt
	H mm	L mm	I mm	kg	Δt50	Δt30	Δt26
FSC125318	1220	560	1160	25	608	320	268
FSC185318	1820	560	1760	38	839	442	369
FSC205318	2020	560	1960	43	903	473	394

La tonalità di colore del metacrilato è indicativa.

*The Acrylic color hue may change slightly.*

*La tonalité de la couleur du Acrylic est indicative.*

*Der Acrylic Farbton ist richtungsweisend.*

*La tonalidad del color del Acrylic es indicativa.*

# scuba COMBINATION 19

ice bianco + metacrilato nero

## ICE

colore	colour	couleur	Farbe	color
bianco puro opaco RAL 9010	pure white matt RAL 9010	blanc pur mat RAL 9010	mattes reines Weiß RAL 9010	blanco puro mate RAL 9010

## Metacrilato / Acryl

colore	colour	couleur	Farbe	color
nero	black	noir	schwarz	negro

$$\text{Watt} = \text{Kcal/h} \div 0,860$$

$$\text{Kcal/h} = \text{Watt} \times 0,860$$

codice code code Code codigo	altezza height hauteur hoehe altura	larghezza width breite largeur longitud	interasse distance between bars entraxe achsabstand centros	peso weight poids gewicht peso	output 75/65-20 watt	output 55/45-20 watt	output 55/45-24 watt
	H mm	L mm	I mm	kg	Δt50	Δt30	Δt26
FSC125319	1220	560	1160	25	608	320	268
FSC185319	1820	560	1760	38	839	442	369
FSC205319	2020	560	1960	43	903	473	394

La tonalità di colore del metacrilato è indicativa.

*The Acrylic color hue may change slightly.*

*La tonalité de la couleur du Acrylic est indicative.*

*Der Acrylic Farbton ist richtungsweisend.*

*La tonalidad del color del Acrylic es indicativa.*

# scuba COMBINATION 20

ice satinato + metacrilato nero

## ICE

colore	colour	couleur	Farbe	color
satinato	satinated	satiné	satiniert	satinado

## Metacrilato / Acryl

colore	colour	couleur	Farbe	color
nero	black	noir	schwarz	negro

$$\text{Watt} = \text{Kcal/h} \div 0,860$$

$$\text{Kcal/h} = \text{Watt} \times 0,860$$

codice code code Code codigo	altezza height hauteur hoehe altura	larghezza width breite largeur longitud	interasse distance between bars entraxe achsabstand centros	peso weight poids gewicht peso	output 75/65-20 watt	output 55/45-20 watt	output 55/45-24 watt
	H mm	L mm	I mm	kg	Δt50	Δt30	Δt26
FSC125320	1220	560	1160	25	608	320	268
FSC185320	1820	560	1760	38	839	442	369
FSC205320	2020	560	1960	43	903	473	394

La tonalità di colore del metacrilato è indicativa.

*The Acrylic color hue may change slightly.*

*La tonalité de la couleur du Acrylic est indicative.*

*Der Acrylic Farbton ist richtungsweisend.*

*La tonalidad del color del Acrylic es indicativa.*

# scuba COMBINATION 21

ice bianco + metacrilato verde

## ICE

colore	colour	couleur	Farbe	color
bianco puro opaco RAL 9010	pure white matt RAL 9010	blanc pur mat RAL 9010	mattes reines Weiß RAL 9010	blanco puro mate RAL 9010

## Metacrilato / Acryl

colore	colour	couleur	Farbe	color
verde	green	vert	grün	verde

$$\text{Watt} = \text{Kcal/h} \div 0,860$$

$$\text{Kcal/h} = \text{Watt} \times 0,860$$

codice code code Kode codigo	altezza height hauteur hoehe altura	larghezza width breite largeur longitud	interasse distance between bars entraxe achsabstand centros	peso weight poids gewicht peso	output 75/65-20 watt	output 55/45-20 watt	output 55/45-24 watt
	H mm	L mm	I mm	kg	Δt50	Δt30	Δt26
FSC125321	1220	560	1160	25	608	320	268
FSC185321	1820	560	1760	38	839	442	369
FSC205321	2020	560	1960	43	903	473	394

La tonalità di colore del metacrilato è indicativa.

*The Acrylic color hue may change slightly.*

*La tonalité de la couleur du Acrylic est indicative.*

*Der Acrylic Farbton ist richtungsweisend.*

*La tonalidad del color del Acrylic es indicativa.*

# scuba COMBINATION 22

ice nero + metacrilato verde

## ICE

colore	colour	couleur	Farbe	color
nero puro opaco RAL 9005	pure black matt RAL 9005	noir pur mat RAL 9005	mattes reines schwarz RAL 9005	negro puro mate RAL 9005

## Metacrilato / Acryl

colore	colour	couleur	Farbe	color
verde	green	vert	grün	verde

$$\text{Watt} = \text{Kcal/h} \div 0,860$$

$$\text{Kcal/h} = \text{Watt} \times 0,860$$

codice code code Kode codigo	altezza height hauteur hoehe altura	larghezza width breite largeur longitud	interasse distance between bars entraxe achsabstand centros	peso weight poids gewicht peso	output 75/65-20 watt	output 55/45-20 watt	output 55/45-24 watt
	H mm	L mm	I mm	kg	Δt50	Δt30	Δt26
FSC125322	1220	560	1160	25	608	320	268
FSC185322	1820	560	1760	38	839	442	369
FSC205322	2020	560	1960	43	903	473	394

La tonalità di colore del metacrilato è indicativa.

*The Acrylic color hue may change slightly.*

*La tonalité de la couleur du Acrylic est indicative.*

*Der Acrylic Farbton ist richtungsweisend.*

*La tonalidad del color del Acrylic es indicativa.*

# scuba COMBINATION 23

ice bianco + metacrilato azzurro

## ICE

colore	colour	couleur	Farbe	color
bianco puro opaco RAL 9010	pure white matt RAL 9010	blanc pur mat RAL 9010	mattes reines Weiß RAL 9010	blanco puro mate RAL 9010

## Metacrilato / Acryl

colore	colour	couleur	Farbe	color
azzurro	light blue	azuré	blau	azul

$$\text{Watt} = \text{Kcal/h} \div 0,860$$

$$\text{Kcal/h} = \text{Watt} \times 0,860$$

codice code code Kode codigo	altezza height hauteur hoehe altura	larghezza width breite largeur longitud	interasse distance between bars entraxe achsabstand centros	peso weight poids gewicht peso	output	output	output
	H mm	L mm	I mm	kg	Δt50 watt	Δt30 watt	Δt26 watt
FSC125323	1220	560	1160	25	608	320	268
FSC185323	1820	560	1760	38	839	442	369
FSC205323	2020	560	1960	43	903	473	394

La tonalità di colore del metacrilato è indicativa.

*The Acrylic color hue may change slightly.*

*La tonalité de la couleur du Acrylic est indicative.*

*Der Acrylic Farbton ist richtungsweisend.*

*La tonalidad del color del Acrylic es indicativa.*

# scuba COMBINATION 24

ice nero + metacrilato azzurro

## ICE

colore	colour	couleur	Farbe	color
nero puro opaco RAL 9005	pure black matt RAL 9005	noir pur mat RAL 9005	mattes reines schwarz RAL 9005	negro puro mate RAL 9005

## Metacrilato / Acryl

colore	colour	couleur	Farbe	color
azzurro	light blue	azuré	blau	azul

$$\text{Watt} = \text{Kcal/h} \div 0,860$$

$$\text{Kcal/h} = \text{Watt} \times 0,860$$

codice code code Kode codigo	altezza height hauteur hoehe altura	larghezza width breite largeur longitud	interasse distance between bars entraxe achsabstand centros	peso weight poids gewicht peso	output	output	output
	H mm	L mm	I mm	kg	Δt50 watt*	Δt30 watt	Δt26 watt
FSC125324	1220	560	1160	25	608	320	268
FSC185324	1820	560	1760	38	839	442	369
FSC205324	2020	560	1960	43	903	473	394

La tonalità di colore del metacrilato è indicativa.

*The Acrylic color hue may change slightly.*

*La tonalité de la couleur du Acrylic est indicative.*

*Der Acrylic Farbton ist richtungsweisend.*

*La tonalidad del color del Acrylic es indicativa.*



GARANZIA 5 ANNI  
GUARANTEE 5 YEARS  
GARANTIE 5 ANS  
GARANTIE 5 JAHRE  
GARANTÍA 5 AÑOS





Design by James Di Marco

# wall collection

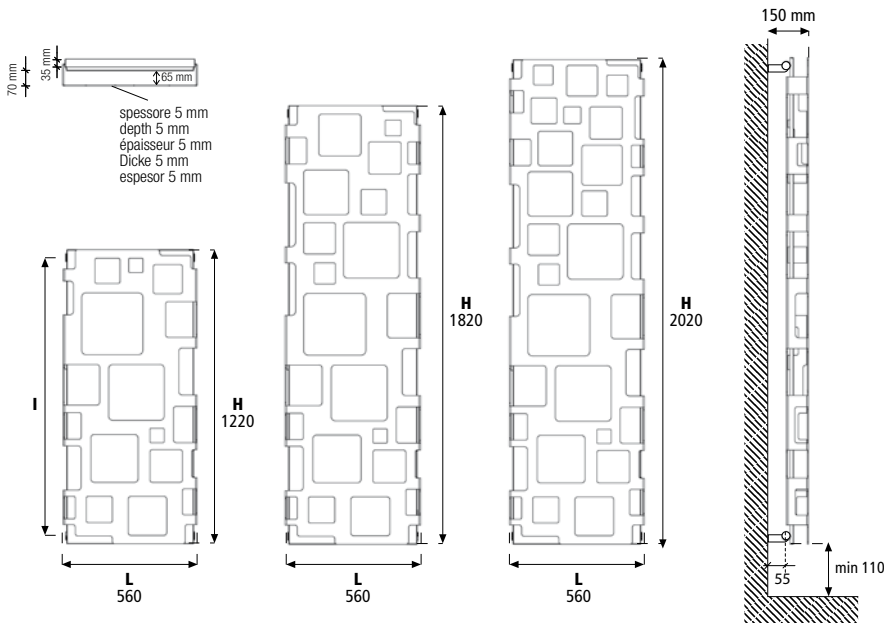

Interasse dal centro foro al muro 55 mm.  
 Distance between hole center and wall 55 mm.  
 Distance du centre du trou au mur 55 mm.  
 Abstand zwischen Lochsmitte und Wand 55 mm.  
 Distancia entre el centro del agujero y el muro 55 mm.

**I radiatori sono completi di kit di fissaggio a parete e valvola di sfianto.**  
**Pressione di collaudo: 5,2 bar - Pressione di esercizio: 4 bar.**  
**Materiale: acciaio al carbonio + metacrilato.**

The radiators are equipped with a kit for fixing them to the wall and with an exhaust valve.  
 Testing pressure: 5,2 bar - Working pressure: 4 bar. Material: carbon steel + Acrylic.

Les radiateurs sont munis d'un kit de fixation murale et d'une soupape de décompression.  
 Pression d'essai: 5,2 bars - Pression d'exercice: 4 bars. Matière: Acier au charbon + Acrylic.

Die Heizkörper sind mit Wandbefestigungsset und Luftventil ausgerüstet.  
 Prüfungsdruck: 5,2 bar Betriebsdruck: 4 bar. Stoff: Kohlenstoffstahl + Acrylic.

Los radiadores están provistos de kit de fijación a la pared y de válvula de desahogo.  
 Presión de ensayo: 5,2 bar - Presión de trabajo: 4 bar. Material: Acero de carbono + Acrylic.



Wall disponibile anche in versione solo elettrica o mista, consultare il listino radiatori elettrici.  
 Wall available also in electric version or dual energy version, please see our electric radiators price list.  
 Wall disponible dans la version seulement électrique ou dans la version mixte, voir le tarif radiateurs électriques.  
 Wall in elektrischer Ausführung oder in gemischter Ausführung verfügbar, bitte sehen Sie die elektrische Heizkörper-Preisliste.  
 Wall puede ser instalado también en versión solo eléctrica o en versión mixta consultar el listino de precios Versión eléctrica.

Interasse Centrale 50 mm **a richiesta.**  
 Central distance between centers 50 mm **on request.**  
 Entraxe centrale 50 mm **sur demande.**  
 Mitteanschluss 50 mm **Auf Anfrage.**  
 Distancia entre centros de 50 mm, **bajo pedido.**

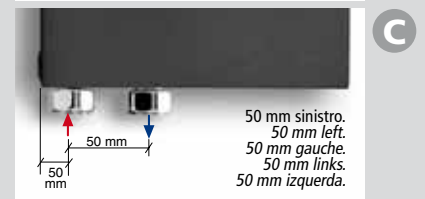
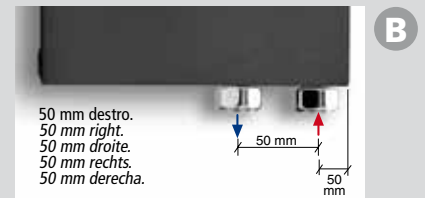
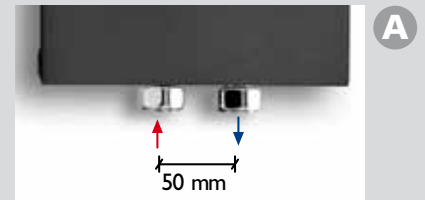

Allacciamento dal basso **a richiesta.**  
 Bottom connection **on request.**  
 Branchement par dessous **sur demande.**  
 Anschluss von unten **Auf Anfrage.**  
 Conexión por abajo **bajo pedido.**

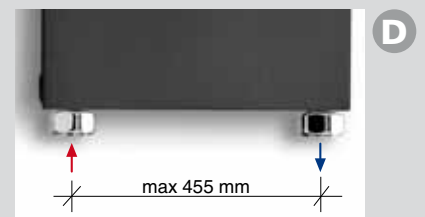

Allacciamenti possibili.  
 Possible connections.  
 Branchements possibles.  
 Mögliche Anschlüsse.  
 Empalmes standard.

**A richiesta**, il modello Wall può essere previsto per il montaggio in orizzontale con maggiorazione del 7%  
**On request** Wall can be produced for being mounting horizontally with 7% price surcharge  
**Sur demande** Wall peut être prévu pour l'installation en horizontal avec majoration du prix du 7%  
**Auf Anfrage** kann Wall gefertigt werden, um es horizontal zu montieren. Mehrpreis von 7%.  
**Bajo pedido** el modelo Wall puede ser previsto por el montaje en horizontal con aumento de 7%.

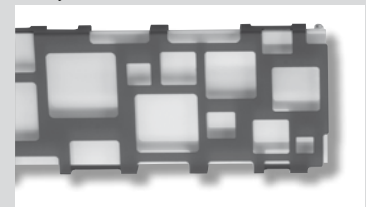



# wall COMBINATION 25

ice bianco + metacrilato arancio



## ICE

colore	colour	couleur	Farbe	color
bianco puro opaco RAL 9010	pure white matt RAL 9010	blanc pur mat RAL 9010	mattes reines Weiß RAL 9010	blanco puro mate RAL 9010

## Metacrilato / Acryl

colore	colour	couleur	Farbe	color
arancio	orange	orange	orange	anaranjado

$$\text{Watt} = \text{Kcal/h} \div 0,860$$

$$\text{Kcal/h} = \text{Watt} \times 0,860$$

codice code code code code codigo	altezza height hauteur hoehe altura	larghezza width breite largeur longitud	interasse distance between bars entraxe achsabstand centros	peso weight poids gewicht peso	output watt	output watt	output watt
	H mm	L mm	I mm	kg	$\Delta t50$	$\Delta t30$	$\Delta t26$
FWA125325	1220	560	1160	25	608	320	268
FWA185325	1820	560	1760	38	839	442	369
FWA205325	2020	560	1960	43	903	473	394

La tonalità di colore del metacrilato è indicativa.

*The Acrylic color hue may change slightly.*

*La tonalité de la couleur du Acrylic est indicative.*

*Der Acrylic Farbton ist richtungsweisend.*

*La tonalidad del color del Acrylic es indicativa.*



# wall COMBINATION 26

ice satinato + metacrilato arancio



## ICE

colore	colour	couleur	Farbe	color
satinato	satinated	satiné	satiniert	satinado

## Metacrilato / Acryl

colore	colour	couleur	Farbe	color
arancio	orange	orange	orange	anaranjado

$$\text{Watt} = \text{Kcal/h} \div 0,860$$

$$\text{Kcal/h} = \text{Watt} \times 0,860$$

codice code code code code codigo	altezza height hauteur hoehe altura	larghezza width breite largeur longitud	interasse distance between bars entraxe achsabstand centros	peso weight poids gewicht peso	output watt	output watt	output watt
	H mm	L mm	I mm	kg	$\Delta t50$	$\Delta t30$	$\Delta t26$
FWA125326	1220	560	1160	25	608	320	268
FWA185326	1820	560	1760	38	839	442	369
FWA205326	2020	560	1960	43	903	473	394

La tonalità di colore del metacrilato è indicativa.

*The Acrylic color hue may change slightly.*

*La tonalité de la couleur du Acrylic est indicative.*

*Der Acrylic Farbton ist richtungsweisend.*

*La tonalidad del color del Acrylic es indicativa.*



# wall COMBINATION 27

ice bianco + metacrilato rosso



## ICE

colore	colour	couleur	Farbe	color
bianco puro opaco RAL 9010	pure white matt RAL 9010	blanc pur mat RAL 9010	mattes reines Weiß RAL 9010	blanco puro mate RAL 9010

## Metacrilato / Acryl

colore	colour	couleur	Farbe	color
rosso	red	rouge	rot	rojo

Watt=Kcal/h ÷ 0,860  
Kcal/h= Watt x 0,860

codice code code Kode codigo	altezza height hauteur hoehe altura	larghezza width breite largeur longitud	interasse distance between bars entraxe achsabstand centros	peso weight poids gewicht peso	output watt	output watt	output watt
	H mm	L mm	I mm	kg	Δt50	Δt30	Δt26
FWA125327	1220	560	1160	25	608	320	268
FWA185327	1820	560	1760	38	839	442	369
FWA205327	2020	560	1960	43	903	473	394

La tonalità di colore del metacrilato è indicativa.

*The Acrylic color hue may change slightly.*

*La tonalité de la couleur du Acrylic est indicative.*

*Der Acrylic Farbton ist richtungsweisend.*

*La tonalidad del color del Acrylic es indicativa.*



# wall COMBINATION 28

ice satinato + metacrilato rosso



## ICE

colore	colour	couleur	Farbe	color
satinato	satinated	satiné	satiniert	satinado

## Metacrilato / Acryl

colore	colour	couleur	Farbe	color
rosso	red	rouge	rot	rojo

Watt=Kcal/h ÷ 0,860  
Kcal/h= Watt x 0,860

codice code code Kode codigo	altezza height hauteur hoehe altura	larghezza width breite largeur longitud	interasse distance between bars entraxe achsabstand centros	peso weight poids gewicht peso	output watt	output watt	output watt
	H mm	L mm	I mm	kg	Δt50	Δt30	Δt26
FWA125328	1220	560	1160	25	608	320	268
FWA185328	1820	560	1760	38	839	442	369
FWA205328	2020	560	1960	43	903	473	394

La tonalità di colore del metacrilato è indicativa.

*The Acrylic color hue may change slightly.*

*La tonalité de la couleur du Acrylic est indicative.*

*Der Acrylic Farbton ist richtungsweisend.*

*La tonalidad del color del Acrylic es indicativa.*



# wall COMBINATION 29

ice nero + metacrilato neutro trasparente



## ICE

colore	colour	couleur	Farbe	color
nero puro opaco RAL 9005	pure black matt RAL 9005	noir pur mat RAL 9005	mattes reines schwarz RAL 9005	negro puro mate RAL 9005

## Metacrilato / Acryl

colore	colour	couleur	Farbe	color
neutro trasparente	neutral transparent	neutre transparente	transparent	neutro trasparente

$$\text{Watt} = \text{Kcal/h} \div 0,860$$

$$\text{Kcal/h} = \text{Watt} \times 0,860$$

codice code code Kode codigo	altezza height hauteur hoehe altura <b>H mm</b>	larghezza width breite largeur longitud <b>L mm</b>	interasse distance between bars entraxe achsabstand centros <b>I mm</b>	peso weight poids gewicht peso <b>kg</b>	output	output	output
					75/65-20 watt $\Delta t50$	55/45-20 watt $\Delta t30$	55/45-24 watt $\Delta t26$
FWA125329	1220	560	1160	25	608	320	268
FWA185329	1820	560	1760	38	839	442	369
FWA205329	2020	560	1960	43	903	473	394

La tonalità di colore del metacrilato è indicativa.

*The Acrylic color hue may change slightly.*

*La tonalité de la couleur du Acrylic est indicative.*

*Der Acrylic Farbton ist richtungsweisend.*

*La tonalidad del color del Acrylic es indicativa.*



# wall COMBINATION 30

ice satinato + metacrilato neutro trasparente



## ICE

colore	colour	couleur	Farbe	color
satinato	satinated	satiné	satiniert	satinado

## Metacrilato / Acryl

colore	colour	couleur	Farbe	color
neutro trasparente	neutral transparent	neutre transparente	transparent	neutro trasparente

$$\text{Watt} = \text{Kcal/h} \div 0,860$$

$$\text{Kcal/h} = \text{Watt} \times 0,860$$

codice code code Kode codigo	altezza height hauteur hoehe altura <b>H mm</b>	larghezza width breite largeur longitud <b>L mm</b>	interasse distance between bars entraxe achsabstand centros <b>I mm</b>	peso weight poids gewicht peso <b>kg</b>	output	output	output
					75/65-20 watt $\Delta t50$	55/45-20 watt $\Delta t30$	55/45-24 watt $\Delta t26$
FWA125330	1220	560	1160	25	608	320	268
FWA185330	1820	560	1760	38	839	442	369
FWA205330	2020	560	1960	43	903	473	394

La tonalità di colore del metacrilato è indicativa.

*The Acrylic color hue may change slightly.*

*La tonalité de la couleur du Acrylic est indicative.*

*Der Acrylic Farbton ist richtungsweisend.*

*La tonalidad del color del Acrylic es indicativa.*



# wall COMBINATION 31

ice bianco + metacrilato nero



## ICE

colore	colour	couleur	Farbe	color
bianco puro opaco RAL 9010	pure white matt RAL 9010	blanc pur mat RAL 9010	mattes reines Weiß RAL 9010	blanco puro mate RAL 9010

## Metacrilato / Acryl

colore	colour	couleur	Farbe	color
nero	black	noir	schwarz	negro

$$\text{Watt} = \text{Kcal/h} \div 0,860$$

$$\text{Kcal/h} = \text{Watt} \times 0,860$$

codice code code Kode codigo	altezza height hauteur hoehe altura	larghezza width breite largeur longitud	interasse distance between bars entraxe achsabstand centros	peso weight poids gewicht peso	output watt	output watt	output watt
	H mm	L mm	I mm	kg	Δt50	Δt30	Δt26
FWA125331	1220	560	1160	25	608	320	268
FWA185331	1820	560	1760	38	442	442	369
FWA205331	2020	560	1960	43	903	473	394

La tonalità di colore del metacrilato è indicativa.

*The Acrylic color hue may change slightly.*

*La tonalité de la couleur du Acrylic est indicative.*

*Der Acrylic Farbton ist richtungsweisend.*

*La tonalidad del color del Acrylic es indicativa.*



# wall COMBINATION 32

ice satinato + metacrilato nero



## ICE

colore	colour	couleur	Farbe	color
satinato	satinated	satiné	satiniert	satinado

## Metacrilato / Acryl

colore	colour	couleur	Farbe	color
nero	black	noir	schwarz	negro

$$\text{Watt} = \text{Kcal/h} \div 0,860$$

$$\text{Kcal/h} = \text{Watt} \times 0,860$$

codice code code Kode codigo	altezza height hauteur hoehe altura	larghezza width breite largeur longitud	interasse distance between bars entraxe achsabstand centros	peso weight poids gewicht peso	output watt	output watt	output watt
	H mm	L mm	I mm	kg	Δt50	Δt30	Δt26
FWA125332	1220	560	1160	25	608	320	268
FWA185332	1820	560	1760	38	839	442	369
FWA205332	2020	560	1960	43	903	473	394

La tonalità di colore del metacrilato è indicativa.

*The Acrylic color hue may change slightly.*

*La tonalité de la couleur du Acrylic est indicative.*

*Der Acrylic Farbton ist richtungsweisend.*

*La tonalidad del color del Acrylic es indicativa.*

# wall COMBINATION 33

ice bianco + metacrilato verde

EN 442

## ICE

colore	colour	couleur	Farbe	color
bianco puro opaco RAL 9010	pure white matt RAL 9010	blanc pur mat RAL 9010	mattes reines Weiß RAL 9010	blanco puro mate RAL 9010

## Metacrilato / Acryl

colore	colour	couleur	Farbe	color
verde	green	vert	grün	verde

$$\text{Watt} = \text{Kcal/h} \div 0,860$$

$$\text{Kcal/h} = \text{Watt} \times 0,860$$

codice code code Kode codigo	altezza height hauteur hoehe altura	larghezza width breite largeur longitud	interasse distance between bars entraxe achsabstand centros	peso weight poids gewicht peso	output	output	output
					75/65-20	75/65-20	55/45-24
	H mm	L mm	I mm	kg	watt	watt	watt
					$\Delta t50$	$\Delta t30$	$\Delta t26$
FWA125333	1220	560	1160	25	608	320	268
FWA185333	1820	560	1760	38	839	442	369
FWA205333	2020	560	1960	43	903	473	394

La tonalità di colore del metacrilato è indicativa.

*The Acrylic color hue may change slightly.*

*La tonalité de la couleur du Acrylic est indicative.*

*Der Acrylic Farbton ist richtungsweisend.*

*La tonalidad del color del Acrylic es indicativa.*

# wall COMBINATION 34

ice nero + metacrilato verde

EN 442

## ICE

colore	colour	couleur	Farbe	color
nero puro opaco RAL 9005	pure black matt RAL 9005	noir pur mat RAL 9005	mattes reines schwarz RAL 9005	negro puro mate RAL 9005

## Metacrilato / Acryl

colore	colour	couleur	Farbe	color
verde	green	vert	grün	verde

$$\text{Watt} = \text{Kcal/h} \div 0,860$$

$$\text{Kcal/h} = \text{Watt} \times 0,860$$

codice code code Kode codigo	altezza height hauteur hoehe altura	larghezza width breite largeur longitud	interasse distance between bars entraxe achsabstand centros	peso weight poids gewicht peso	output	output	output
					75/65-20	75/65-20	55/45-24
	H mm	L mm	I mm	kg	watt	watt	watt
					$\Delta t50$	$\Delta t30$	$\Delta t26$
FWA125334	1220	560	1160	25	608	320	268
FWA185334	1820	560	1760	38	839	442	369
FWA205334	2020	560	1960	43	903	473	394

La tonalità di colore del metacrilato è indicativa.

*The Acrylic color hue may change slightly.*

*La tonalité de la couleur du Acrylic est indicative.*

*Der Acrylic Farbton ist richtungsweisend.*

*La tonalidad del color del Acrylic es indicativa.*



# wall COMBINATION 35

ice bianco + metacrilato azzurro



## ICE

colore	colour	couleur	Farbe	color
bianco puro opaco RAL 9010	pure white matt RAL 9010	blanc pur mat RAL 9010	mattes reines Weiß RAL 9010	blanco puro mate RAL 9010

## Metacrilato / Acryl

colore	colour	couleur	Farbe	color
azzurro	light blue	azuré	blau	azul

Watt=Kcal/h ÷ 0,860  
Kcal/h= Watt x 0,860

codice code code Kode codigo	altezza height hauteur hoehe altura	larghezza width breite largeur longitud	interasse distance between bars entraxe achsabstand centros	peso weight poids gewicht peso	output watt	output watt	output watt
	H mm	L mm	I mm	kg	Δt50	Δt30	Δt26
FWA125335	1220	560	1160	25	608	320	268
FWA185335	1820	560	1760	38	839	442	369
FWA205335	2020	560	1960	43	903	473	394

La tonalità di colore del metacrilato è indicativa.

*The Acrylic color hue may change slightly.*

*La tonalité de la couleur du Acrylic est indicative.*

*Der Acrylic Farbton ist richtungsweisend.*

*La tonalidad del color del Acrylic es indicativa.*

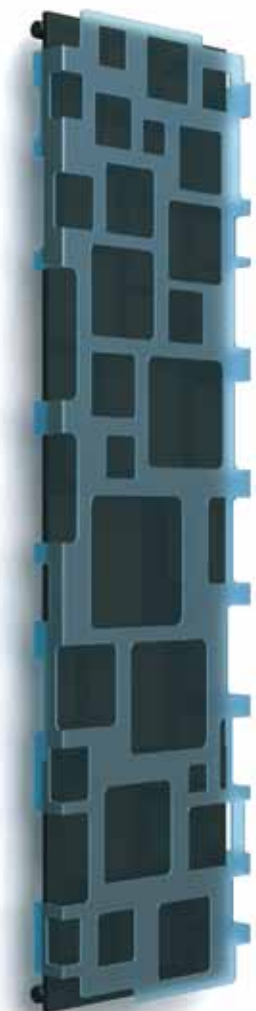

# wall COMBINATION 36

ice nero + metacrilato azzurro



## ICE

colore	colour	couleur	Farbe	color
nero puro opaco RAL 9005	pure black matt RAL 9005	noir pur mat RAL 9005	mattes reines schwarz RAL 9005	negro puro mate RAL 9005

## Metacrilato / Acryl

colore	colour	couleur	Farbe	color
azzurro	light blue	azuré	blau	azul

Watt=Kcal/h ÷ 0,860  
Kcal/h= Watt x 0,860

codice code code Kode codigo	altezza height hauteur hoehe altura	larghezza width breite largeur longitud	interasse distance between bars entraxe achsabstand centros	peso weight poids gewicht peso	output watt	output watt	output watt
	H mm	L mm	I mm	kg	Δt50	Δt30	Δt26
FWA125336	1220	560	1160	25	608	320	268
FWA185336	1820	560	1760	38	839	442	369
FWA205336	2020	560	1960	43	903	473	394

La tonalità di colore del metacrilato è indicativa.

*The Acrylic color hue may change slightly.*

*La tonalité de la couleur du Acrylic est indicative.*

*Der Acrylic Farbton ist richtungsweisend.*

*La tonalidad del color del Acrylic es indicativa.*



GARANZIA 5 ANNI  
GUARANTEE 5 YEARS  
GARANTIE 5 ANS  
GARANTIE 5 JAHRE  
GARANTÍA 5 AÑOS



caleido®  
design radiators



Design by James Di Marco

# digit collection

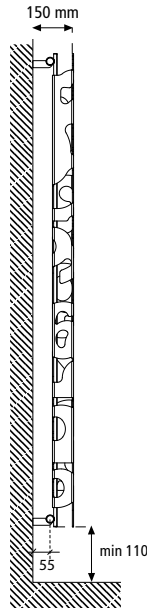
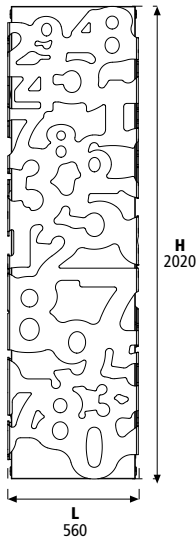
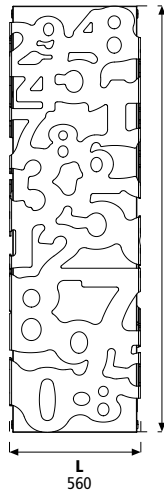
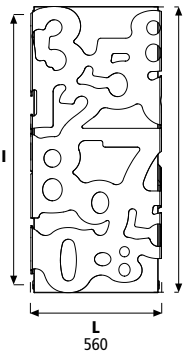
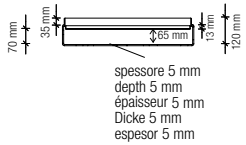

Interasse dal centro foro al muro 55 mm.  
Distance between hole center and wall 55 mm.  
Distance du centre du trou au mur 55 mm.  
Abstand zwischen Lochsmitte und Wand 55 mm.  
Distancia entre el centro del agujero y el muro 55 mm.

**I radiatori sono completi di kit di fissaggio a parete e valvola di sfianto.**  
**Pressione di collaudo: 5,2 bar - Pressione di esercizio: 4 bar.**  
**Materiale: acciaio al carbonio + metacrilato.**

The radiators are equipped with a kit for fixing them to the wall and with an exhaust valve.  
Testing pressure: 5,2 bar - Working pressure: 4 bar. Material: carbon steel + Acrylic.

Les radiateurs sont munis d'un kit de fixation murale et d'une soupape de décompression.  
Pression d'essai: 5,2 bars - Pression d'exercice: 4 bars. Matière: Acier au charbon + Acrylic.

Die Heizkörper sind mit Wandbefestigungsset und Luftventil ausgerüstet.  
Prüfungsdruck: 5,2 bar Betriebsdruck: 4 bar. Stoff: Kohlenstoffstahl + Acrylic.

Los radiadores están provistos de kit de fijación a la pared y de válvula de desahogo.  
Presión de ensayo: 5,2 bar - Presión de trabajo: 4 bar. Material: Acero de carbono + Acrylic.



Digit disponibile anche in versione solo elettrica o mista, consultare il listino radiatori elettrici.  
Digit available also in electric version or dual energy version, please see our electric radiators price list.  
Digit disponible dans la version seulement électrique ou dans la version mixte, voir le tarif radiateurs électriques.  
Digit in elektrischer Ausführung oder in gemischter Ausführung verfügbar, bitte sehen Sie die elektrische Heizkörper-Preisliste.  
Digit puede ser instalado también en versión solo eléctrica o en versión mixta consultar el listino de precios Versión eléctrica.

Interasse Centrale 50 mm **a richiesta.**  
Central distance between centers 50 mm **on request.**  
Entraxe centrale 50 mm **sur demande.**  
Mitteanschluss 50 mm **Auf Anfrage.**  
Distancia entre centros de 50 mm, **bajo pedido.**

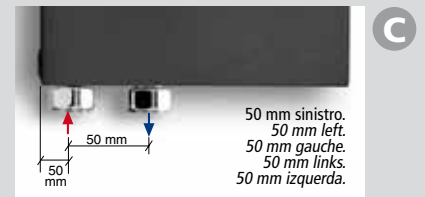
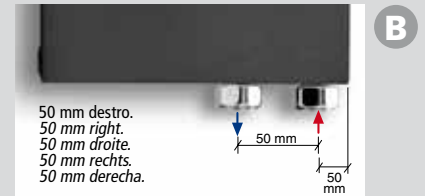
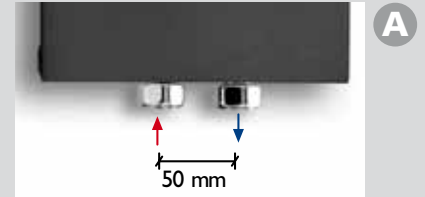

Allacciamento dal basso **a richiesta.**  
Bottom connection **on request.**  
Branchement par dessous **sur demande.**  
Anschluss von unten **Auf Anfrage.**  
Conexión por abajo **bajo pedido.**

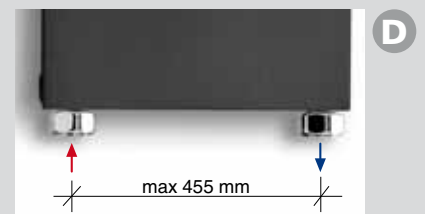

Allacciamenti possibili.  
Possible connections.  
Branchements possibles.  
Mögliche Anschlüsse.  
Empalmes standard.

# digit COMBINATION 49

ice bianco + metacrilato arancio

EN 442

## ICE

colore	colour	couleur	Farbe	color
bianco puro opaco RAL 9010	pure white matt RAL 9010	blanc pur mat RAL 9010	mattes reines Weiß RAL 9010	blanco puro mate RAL 9010

## Metacrilato / Acryl

colore	colour	couleur	Farbe	color
arancio	orange	orange	orange	anaranjado

$$\text{Watt} = \text{Kcal/h} \div 0,860$$

$$\text{Kcal/h} = \text{Watt} \times 0,860$$

codice code code Kode codigo	altezza height hauteur hoehe altura	larghezza width breite largeur longitud	interasse distance between bars entraxe achsabstand centros	peso weight poids gewicht peso	output watt	output watt	output watt
	H mm	L mm	I mm	kg	$\Delta t50$	$\Delta t30$	$\Delta t26$
FDI125349	1220	560	1160	25	608	320	268
FDI185349	1820	560	1760	38	839	442	369
FDI205349	2020	560	1960	43	903	473	394

La tonalità di colore del metacrilato è indicativa.

*The Acrylic color hue may change slightly.*

*La tonalité de la couleur du Acrylic est indicative.*

*Der Acrylic Farbton ist richtungsweisend.*

*La tonalidad del color del Acrylic es indicativa.*

# digit COMBINATION 50

ice satinato + metacrilato arancio

EN 442

## ICE

colore	colour	couleur	Farbe	color
satinato	satinated	satiné	satiniert	satinado

## Metacrilato / Acryl

colore	colour	couleur	Farbe	color
arancio	orange	orange	orange	anaranjado

$$\text{Watt} = \text{Kcal/h} \div 0,860$$

$$\text{Kcal/h} = \text{Watt} \times 0,860$$

codice code code Kode codigo	altezza height hauteur hoehe altura	larghezza width breite largeur longitud	interasse distance between bars entraxe achsabstand centros	peso weight poids gewicht peso	output watt	output watt	output watt
	H mm	L mm	I mm	kg	$\Delta t50$	$\Delta t30$	$\Delta t26$
FDI125350	1220	560	1160	25	608	320	268
FDI185350	1820	560	1760	38	839	442	369
FDI205350	2020	560	1960	43	903	473	394

La tonalità di colore del metacrilato è indicativa.

*The Acrylic color hue may change slightly.*

*La tonalité de la couleur du Acrylic est indicative.*

*Der Acrylic Farbton ist richtungsweisend.*

*La tonalidad del color del Acrylic es indicativa.*

# digit COMBINATION 51

ice bianco + metacrilato rosso



## ICE

colore	colour	couleur	Farbe	color
bianco puro opaco RAL 9010	pure white matt RAL 9010	blanc pur mat RAL 9010	mattes reines Weiß RAL 9010	blanco puro mate RAL 9010

## Metacrilato / Acryl

colore	colour	couleur	Farbe	color
rosso	red	rouge	rot	rojo

codice code code Kode codigo	altezza height hauteur hoehe altura	larghezza width breite largeur longitud	interasse distance between bars entraxe achsabstand centros	peso weight poids gewicht peso	output	output	output
	H mm	L mm	I mm	kg	75/65-20 watt Δt50	75/65-20 watt Δt30	55/45-24 watt Δt26
FDI125351	1220	560	1160	25	608	320	268
FDI185351	1820	560	1760	38	839	442	369
FDI205351	2020	560	1960	43	903	473	394

La tonalità di colore del metacrilato è indicativa.

*The Acrylic color hue may change slightly.*

*La tonalité de la couleur du Acrylic est indicative.*

*Der Acrylic Farbton ist richtungsweisend.*

*La tonalidad del color del Acrylic es indicativa.*

# digit COMBINATION 52

ice satinato + metacrilato rosso



## ICE

colore	colour	couleur	Farbe	color
satinato	satinated	satiné	satiniert	satinado

## Metacrilato / Acryl

colore	colour	couleur	Farbe	color
rosso	red	rouge	rot	rojo

codice code code Kode codigo	altezza height hauteur hoehe altura	larghezza width breite largeur longitud	interasse distance between bars entraxe achsabstand centros	peso weight poids gewicht peso	output	output	output
	H mm	L mm	I mm	kg	75/65-20 watt Δt50	75/65-20 watt Δt30	55/45-24 watt Δt26
FDI125352	1220	560	1160	25	608	320	268
FDI185352	1820	560	1760	38	839	442	369
FDI205352	2020	560	1960	43	903	473	394

La tonalità di colore del metacrilato è indicativa.

*The Acrylic color hue may change slightly.*

*La tonalité de la couleur du Acrylic est indicative.*

*Der Acrylic Farbton ist richtungsweisend.*

*La tonalidad del color del Acrylic es indicativa.*



# digit COMBINATION 53

ice nero + metacrilato neutro trasparente



## ICE

colore	colour	couleur	Farbe	color
nero puro opaco RAL 9005	pure black matt RAL 9005	noir pur mat RAL 9005	mattes reines schwarz RAL 9005	negro puro mate RAL 9005

## Metacrilato / Acryl

colore	colour	couleur	Farbe	color
neutro trasparente	neutral transparent	neutre transparente	transparent	neutro trasparente

$$\text{Watt} = \text{Kcal/h} \div 0,860$$

$$\text{Kcal/h} = \text{Watt} \times 0,860$$

codice code code Kode codigo	altezza height hauteur hoehe altura H mm	larghezza width breite largeur longitud L mm	interasse distance between bars entraxe achsabstand centros I mm	peso weight poids gewicht peso kg	output	output	output
					75/65-20 watt $\Delta t50$	75/65-20 watt $\Delta t30$	55/45-24 watt $\Delta t26$
FDI125353	1220	560	1160	25	608	320	268
FDI185353	1820	560	1760	38	839	442	369
FDI205353	2020	560	1960	43	903	473	394

La tonalità di colore del metacrilato è indicativa.

*The Acrylic color hue may change slightly.*

*La tonalité de la couleur du Acrylic est indicative.*

*Der Acrylic Farbton ist richtungsweisend.*

*La tonalidad del color del Acrylic es indicativa.*



# digit COMBINATION 54

ice satinato + metacrilato neutro trasparente



## ICE

colore	colour	couleur	Farbe	color
satinato	satinated	satiné	satiniert	satinado

## Metacrilato / Acryl

colore	colour	couleur	Farbe	color
neutro trasparente	neutral transparent	neutre transparente	transparent	neutro trasparente

$$\text{Watt} = \text{Kcal/h} \div 0,860$$

$$\text{Kcal/h} = \text{Watt} \times 0,860$$

codice code code Kode codigo	altezza height hauteur hoehe altura H mm	larghezza width breite largeur longitud L mm	interasse distance between bars entraxe achsabstand centros I mm	peso weight poids gewicht peso kg	output	output	output
					75/65-20 watt $\Delta t50$	75/65-20 watt $\Delta t30$	55/45-24 watt $\Delta t26$
FDI125354	1220	560	1160	25	608	320	262
FDI185354	1820	560	1760	38	839	442	369
FDI205354	2020	560	1960	43	903	473	394

La tonalità di colore del metacrilato è indicativa.

*The Acrylic color hue may change slightly.*

*La tonalité de la couleur du Acrylic est indicative.*

*Der Acrylic Farbton ist richtungsweisend.*

*La tonalidad del color del Acrylic es indicativa.*

# digit COMBINATION 55

ice bianco + metacrilato nero



## ICE

colore	colour	couleur	Farbe	color
bianco puro opaco RAL 9010	pure white matt RAL 9010	blanc pur mat RAL 9010	mattes reines Weiß RAL 9010	blanco puro mate RAL 9010

## Metacrilato / Acryl

colore	colour	couleur	Farbe	color
nero	black	noir	schwarz	negro

codice code code Kode codigo	altezza height hauteur hoehe altura	larghezza width breite largeur longitud	interasse distance between bars entraxe achsabstand centros	peso weight poids gewicht peso	output	output	output
	H mm	L mm	I mm	kg	75/65-20 watt Δt50	75/65-20 watt Δt30	55/45-24 watt Δt26
FDI125355	1220	560	1160	25	608	320	268
FDI185355	1820	560	1760	38	839	442	369
FDI205355	2020	560	1960	43	903	473	394

La tonalità di colore del metacrilato è indicativa.

*The Acrylic color hue may change slightly.*

*La tonalité de la couleur du Acrylic est indicative.*

*Der Acrylic Farbton ist richtungsweisend.*

*La tonalidad del color del Acrylic es indicativa.*

# digit COMBINATION 56

ice satinato + metacrilato nero



## ICE

colore	colour	couleur	Farbe	color
satinato	satinated	satiné	satiniert	satinado

## Metacrilato / Acryl

colore	colour	couleur	Farbe	color
nero	black	noir	schwarz	negro

codice code code Kode codigo	altezza height hauteur hoehe altura	larghezza width breite largeur longitud	interasse distance between bars entraxe achsabstand centros	peso weight poids gewicht peso	output	output	output
	H mm	L mm	I mm	kg	75/65-20 watt Δt50	75/65-20 watt Δt30	55/45-24 watt Δt26
FDI125356	1220	560	1160	25	608	320	268
FDI185356	1820	560	1760	38	839	442	369
FDI205356	2020	560	1960	43	903	473	394

La tonalità di colore del metacrilato è indicativa.

*The Acrylic color hue may change slightly.*

*La tonalité de la couleur du Acrylic est indicative.*

*Der Acrylic Farbton ist richtungsweisend.*

*La tonalidad del color del Acrylic es indicativa.*

# digit COMBINATION 57

ice bianco + metacrilato verde



## ICE

colore	colour	couleur	Farbe	color
bianco puro opaco RAL 9010	pure white matt RAL 9010	blanc pur mat RAL 9010	mattes reines Weiß RAL 9010	blanco puro mate RAL 9010

## Metacrilato / Acryl

colore	colour	couleur	Farbe	color
verde	green	vert	grün	verde

$$\text{Watt} = \text{Kcal/h} \div 0,860$$

$$\text{Kcal/h} = \text{Watt} \times 0,860$$

codice code code Kode codigo	altezza height hauteur hoehe altura	larghezza width breite largeur longitud	interasse distance between bars entraxe achsabstand centros	peso weight poids gewicht peso	output	output	output
					75/65-20	75/65-20	55/45-24
	H mm	L mm	I mm	kg	watt	watt	watt
					$\Delta t50$	$\Delta t30$	$\Delta t26$
FDI125357	1220	560	1160	25	608	320	268
FDI185357	1820	560	1760	38	839	442	369
FDI205357	2020	560	1960	43	903	473	394

La tonalità di colore del metacrilato è indicativa.

*The Acrylic color hue may change slightly.*

*La tonalité de la couleur du Acrylic est indicative.*

*Der Acrylic Farbton ist richtungsweisend.*

*La tonalidad del color del Acrylic es indicativa.*

# digit COMBINATION 58

ice nero + metacrilato verde



## ICE

colore	colour	couleur	Farbe	color
nero puro opaco RAL 9005	pure black matt RAL 9005	noir pur mat RAL 9005	mattes reines schwarz RAL 9005	negro puro mate RAL 9005

## Metacrilato / Acryl

colore	colour	couleur	Farbe	color
verde	green	vert	grün	verde

$$\text{Watt} = \text{Kcal/h} \div 0,860$$

$$\text{Kcal/h} = \text{Watt} \times 0,860$$

codice code code Kode codigo	altezza height hauteur hoehe altura	larghezza width breite largeur longitud	interasse distance between bars entraxe achsabstand centros	peso weight poids gewicht peso	output	output	output
					75/65-20	75/65-20	55/45-24
	H mm	L mm	I mm	kg	watt	watt	watt
					$\Delta t50$	$\Delta t30$	$\Delta t26$
FDI125358	1220	560	1160	25	608	320	268
FDI185358	1820	560	1760	38	839	442	369
FDI205358	2020	560	1960	43	903	473	394

La tonalità di colore del metacrilato è indicativa.

*The Acrylic color hue may change slightly.*

*La tonalité de la couleur du Acrylic est indicative.*

*Der Acrylic Farbton ist richtungsweisend.*

*La tonalidad del color del Acrylic es indicativa.*

# digit COMBINATION 59

ice bianco + metacrilato azzurro

EN 442

## ICE

colore	colour	couleur	Farbe	color
bianco puro opaco RAL 9010	pure white matt RAL 9010	blanc pur mat RAL 9010	mattes reines Weiß RAL 9010	blanco puro mate RAL 9010

## Metacrilato / Acryl

colore	colour	couleur	Farbe	color
azzurro	light blue	azuré	blau	azul

codice code code Kode codigo	altezza height hauteur hoehe altura	larghezza width breite largeur longitud	interasse distance between bars entraxe achsabstand centros	peso weight poids gewicht peso	output	output	output
	H mm	L mm	I mm	kg	75/65-20 watt Δt50	75/65-20 watt Δt30	55/45-24 watt Δt26
FDI125359	1220	560	1160	25	608	320	268
FDI185359	1820	560	1760	38	839	442	369
FDI205359	2020	560	1960	43	903	473	394

La tonalità di colore del metacrilato è indicativa.

*The Acrylic color hue may change slightly.*

*La tonalité de la couleur du Acrylic est indicative.*

*Der Acrylic Farbton ist richtungsweisend.*

*La tonalidad del color del Acrylic es indicativa.*

# digit COMBINATION 60

ice nero + metacrilato azzurro

EN 442

## ICE

colore	colour	couleur	Farbe	color
nero puro opaco RAL 9005	pure black matt RAL 9005	noir pur mat RAL 9005	mattes reines schwarz RAL 9005	negro puro mate RAL 9005

## Metacrilato / Acryl

colore	colour	couleur	Farbe	color
azzurro	light blue	azuré	blau	azul

codice code code Kode codigo	altezza height hauteur hoehe altura	larghezza width breite largeur longitud	interasse distance between bars entraxe achsabstand centros	peso weight poids gewicht peso	output	output	output
	H mm	L mm	I mm	kg	75/65-20 watt Δt50	75/65-20 watt Δt30	55/45-24 watt Δt26
FDI125360	1220	560	1160	25	608	320	268
FDI185360	1820	560	1760	38	839	442	369
FDI205360	2020	560	1960	43	903	473	394

La tonalità di colore del metacrilato è indicativa.

*The Acrylic color hue may change slightly.*

*La tonalité de la couleur du Acrylic est indicative.*

*Der Acrylic Farbton ist richtungsweisend.*

*La tonalidad del color del Acrylic es indicativa.*