

ORDER EXAMPLE

To correctly order this model follow the example specified below:

PRODUCT	BA15K#120050 OB1 ST 9010
BA15K#120050	Article code found in the prices table on the side
OB1	Connector code found in the table here below
ST	Standard Support code found in the table here below
9010	Colour code found in the TUBES COLOUR CHART

ACCESSORIES	
Z1TLNR#AN R12 9010	Valve and Lockshield - Copper angle 1/2" for copper pipes or multi-layer pipes - White RAL 9010
Z1RAC#R12CRO	12mm diam. copper pipe unions for Valve+Lockshield – chrome finish (2)

For other types of Valves see the table below or those on pages 217 - 218 - 219 - 220.

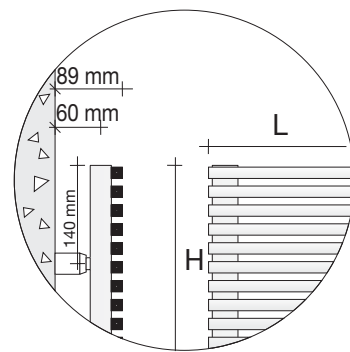

CONNECTORS

The towel warmers are supplied with "OB1" connectors.

If different connectors are required, strictly indicate this in the order. **IMPORTANT:** the connectors of towel warmers and radiators connected to the same system should all have the same configuration otherwise operating problems could occur.

Standard connectors

Will be supplied if not otherwise specified when placing the order

Rear connector

Supplied on request WITH an additional price charge of €

Custom-made connectors

Supplied on request WITH an additional price charge of € (NOT available in chrome-plated version)

Connectors on request

Supplied on request WITHOUT an additional price charge

Custom-made connectors

Supplied on request WITH an additional price charge of € (NOT available in chrome-plated version)

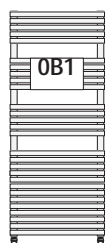

Inter-axis
l=L-3,4 cm



l=L-3,4 cm
rear connector for connection to **GVR**

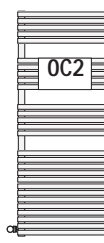

Inter-axis
l=L+13,8 cm

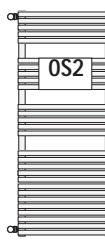

Inter-axis
l=H-5,5 cm

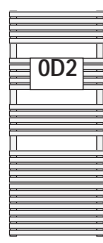

Inter-axis
l=H-5,5 cm



single pipe

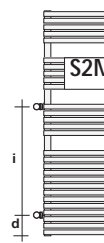

Specify "i" and "d"
i min.=5 cm
d min.=2 cm

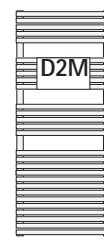

SUPPORTS

The towel warmers are supplied with standard supports (code ST) that include wall fixing shelves, pressure anchors and manual Vent Valve.

On request they can be ordered with bracket supports that are permanently welded on the towel warmers and therefore must be specified when placing the order, their code and cost are as follows:

code MD	WALL TYPE bracket support on the Right	€
code MS	WALL TYPE bracket support on the Left	€
code SO	CEILING TYPE bracket support	€

LIMITS

WALL TYPE bracket support	Width max 60.0 cm
CEILING TYPE bracket support	Width max 80.0 cm

The Chrome plated version cannot be supplied with bracket supports

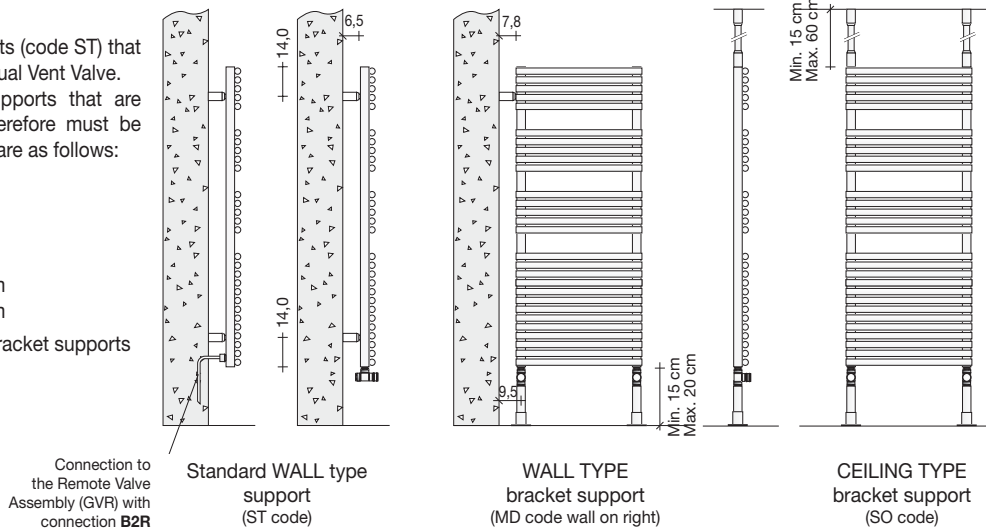

ADDITIONAL CHARGES FOR COLOURS AND FINISHES (see the official Tubes Colour Chart)

RAL colours not included in the colour chart + 30% more than Pure white price (cat. C0), for colours according to samples request feasibility and estimate.

PLATED finishes: Nickel Satin finish (NIS code) NOT available, 14kt GOLD finish (cat. G5)+50% and 24kt GOLD (cat. G6)+60% more than Chrome (Cat.G0).

Standard VALVES (for Valves and Lockshields, valves that can be fitted with thermostat, Thermostatic valves, or Single pipe, Twin pipe, Stainless steel and thermostatic heads see pages 217 - 218 - 219 - 220)

	code	Description	Price
	Z1TLNR#ANR129010	Valve and Lockshield - ValCOLOR Copper Angle 1/2" RAL 9010 Glossy Pure White	€
	Z1RAC#R12CRO	2 copper unions diam. 12 mm for ValCOLOR Chrome finish Valve+Lockshield	€
	ZRCF#	Kit with pipe collars for towel warmers	€

	code	Description	Price
	GVR#	Valve and Lockshield assembly for recessed remote connection, CHROME finish	€
	GVR#	Valve and Lockshield assembly for recessed remote connection, COLOUR finish	€

KUBIK BA15K

Price per radiator with White RAL 9010 finish and standard connectors - VAT and transport charges excluded

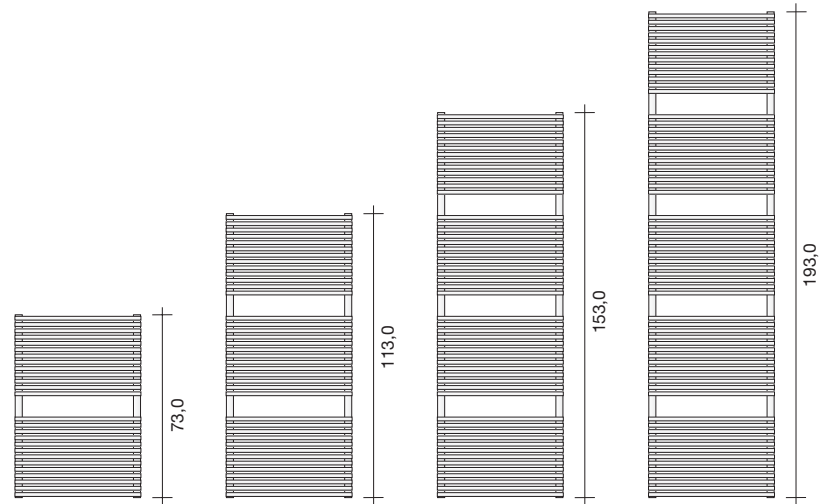

Code	H (cm)	L (cm)	Inter-axis (cm)	Water Content (l)	Coloured version		Chrome plated version		Chrome plated G0 * (€)	Category C0 RAL 9010 (€)	Category C1/C2 (€)	Category C3 (€)
					Watts ΔT 50°C	Watts ΔT 30°C	Watts ΔT 50°C	Watts ΔT 30°C				
BA15K#070040	73,0	40,0	36,6	1,50	350	186	237	126				
BA15K#070050		50,0	46,6	1,87	455	244	296	159				
BA15K#070060		60,0	56,6	2,25	562	305	355	193				
BA15K#120040	113,0	40,0	36,6	2,25	516	276	348	186				
BA15K#120050		50,0	46,6	2,81	657	354	435	234				
BA15K#120060		60,0	56,6	3,37	800	435	522	284				
BA15K#150040	153,0	40,0	36,6	3,00	712	380	454	242				
BA15K#150050		50,0	46,6	3,74	893	480	567	305				
BA15K#150060		60,0	56,6	4,49	1077	582	681	368				
BA15K#190040	193,0	40,0	36,6	3,74	859	457	570	304				
BA15K#190050		50,0	46,6	4,68	1074	579	712	384				
BA15K#190060		60,0	56,6	5,62	1294	707	855	467				

In the CHROME (plated) version the code BA15K becomes BA15KG
For correction factors different to ΔT 50°C see page 230

* Additional charge for the new galvanic finishings Black Nichel and Tin Glossy +10% on the Chrome version. The same additional charge is valid for the valves too.

ORDER EXAMPLE

To correctly order this model follow the example specified below:

PRODUCT

BA15K i5#120050
0i5
ST
9010

BA15Ki5#120050 0i5 ST 9010

Article code found in the prices table here below
Connection code for 5 cm interaxis
Standard Support code found in the table here below
Colour code found in the TUBES COLOUR CHART

ACCESSORIES

Z1TLNR#AN R12 9010
Z1RAC#R12CRO

Valve and Lockshield - Copper angle 1/2" for copper pipes or multi-layer pipes - White RAL 9010
12mm diam. copper pipe unions for Valve+Lockshield – chrome finish (2)

For other types of Valves see the table below or those on pages 217 - 218 - 219 - 220.

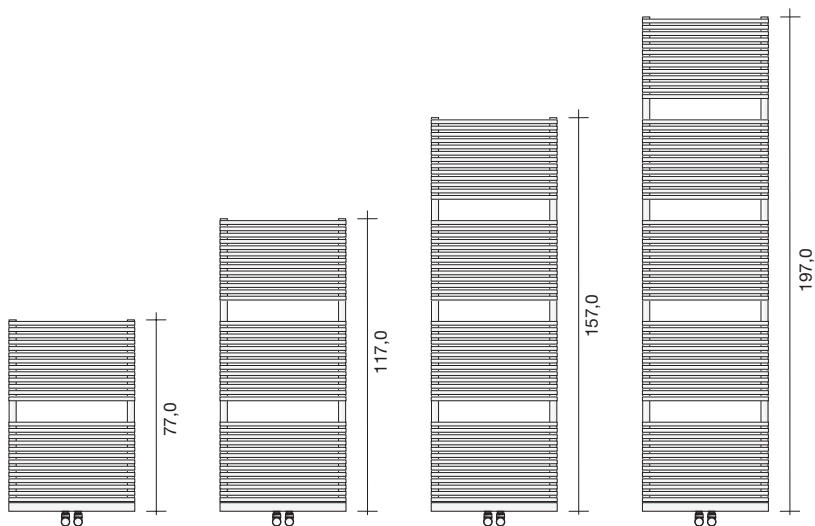
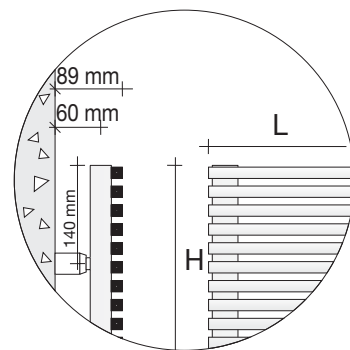

Technical diagram for BA15K i5 connection

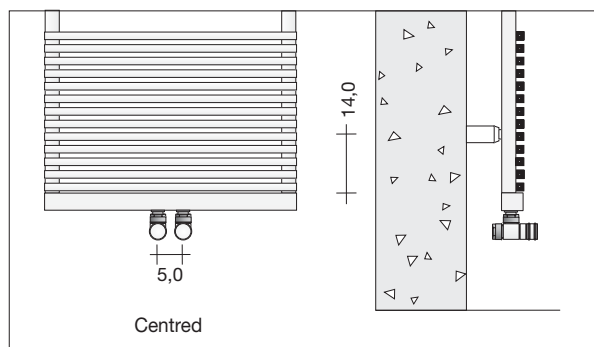

ADDITIONAL CHARGES FOR COLOURS AND FINISHES (see the official Tubes Colour Chart)

RAL colours not included in the colour chart + 30% more than Pure white price (cat. C0), for colours according to samples request feasibility and estimate.
PLATED finishes: Nickel Satin finish (NIS code) NOT available, 14kt GOLD finish (cat. G5)+50% and 24kt GOLD (cat. G6)+60% more than Chrome (Cat.G0).

Standard VALVES (for Valves and Lockshields, valves that can be fitted with thermostat, Thermostatic valves, or Single pipe, Twin pipe, Stainless steel and thermostatic heads see pages 217 - 218 - 219 - 220)

	code	Description	Price		code	Description	Price 9010	Price Cromo
	Z1TLNR#ANR129010	Valve and Lockshield - ValCOLOR Copper Angle 1/2" RAL 9010 Glossy Pure White	€		Z1TL5NR#ANR12SX...	Valves with 5 cm interaxis 5 cm - Left	€	€
	Z1RAC#R12CRO	2 copper unions diam. 12 mm for ValCOLOR Chrome finish Valve+Lockshield	€		Z1TL5NR#ANR12DX...	Valves with 5 cm interaxis 5 cm - Right	€	€
	ZRCF#	Kit with pipe collars for towel warmers	€					

KUBIK BA15K i5

Towel warmer composed of horizontal fusion welded elements in 15x15 mm square section steel with 28 mm diam. manifolds



Code	H (cm)	L (cm)	Inter-axis (cm)	Water Content (l)	Coloured version		Chrome plated version		Chrome plated G0 * (€)	Category C0 RAL 9010 (€)	Category C1/C2 (€)	Category C3 (€)
					Watts ΔT 50°C	Watts ΔT 30°C	Watts ΔT 50°C	Watts ΔT 30°C				
BA15K15#070040	77,0	40,0	5	1,50	350	186	237	126				
BA15K15#070050		50,0	5	1,87	455	244	296	159				
BA15K15#070060		60,0	5	2,25	562	305	355	193				
BA15K15#120040	117,0	40,0	5	2,25	516	276	348	186				
BA15K15#120050		50,0	5	2,81	657	354	435	234				
BA15K15#120060		60,0	5	3,37	800	435	522	284				
BA15K15#150040	157,0	40,0	5	3,00	712	380	454	242				
BA15K15#150050		50,0	5	3,74	893	480	567	305				
BA15K15#150060		60,0	5	4,49	1077	582	681	368				
BA15K15#190040	197,0	40,0	5	3,74	859	457	570	304				
BA15K15#190050		50,0	5	4,68	1074	579	712	384				
BA15K15#190060		60,0	5	5,62	1294	707	855	467				

For correction factors different to ΔT 50°C see page 230

* Additional charge for the new galvanic finishings Black Nichel and Tin Glossy +10% on the Chrome version. The same additional charge is valid for the valves too.

KUBIK BA15K E/M Electric and Mixed

Towel warmer composed of horizontal fusion welded elements in 15x15 mm square section steel with 28 mm diam. manifolds



ORDER EXAMPLE

To correctly order this model follow the example specified below:

PRODUCT **BA15KE#080050 A2 ST 9010**
 BA15KE#080050 Article code found in the prices table on the side
 A2 (KA2 x mixed) Resistor code found in the table on the side
 ST Standard Support code, only one support code available for Electric and Mixed version
 9010 Colour code found in the TUBES COLOUR CHART

ACCESSORIES ELECTRIC/MIXED version (only for standard STD resistors)
 ZRF004 Kit with wireless room thermostat
 Or ZRF005 Portable, programmable digital wireless chronothermostat kit

ACCESSORIES for MIXED version
 Z1TLNR#AN R12 9010 Valve and Lockshield - Copper angle 1/2" for copper pipes or multi-layer pipes - White RAL 9010
 Z1RAC#R12CRO 12mm diam. copper pipe unions for Valve+Lockshield – chrome finish (2)

For other types of Valves see the table below or those on pages 217 - 218 - 219 - 220.

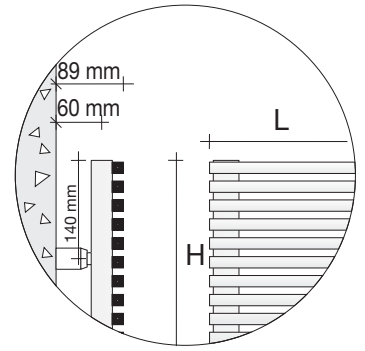

Electric Standard

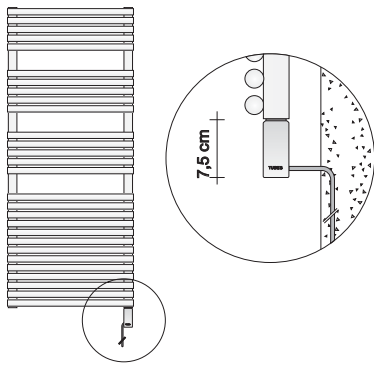

Mixed Standard with Rear Connectors

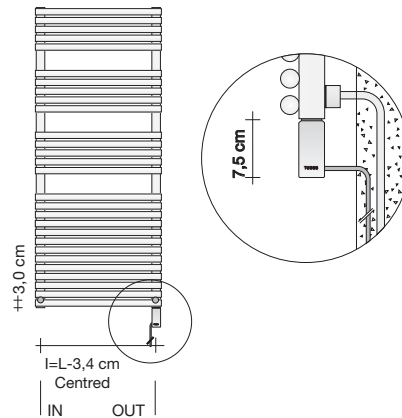

Mixed with Kit and external Connectors

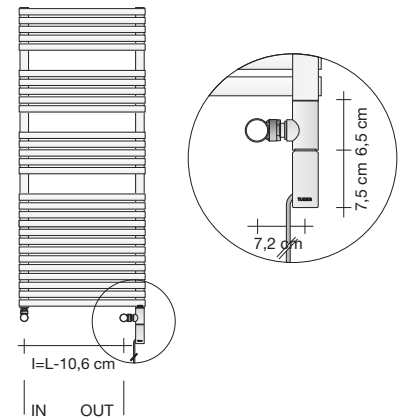

Electric with Room Thermostat

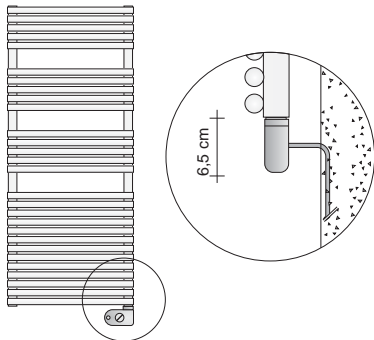

Mixed with Room thermostat and Rear Connectors

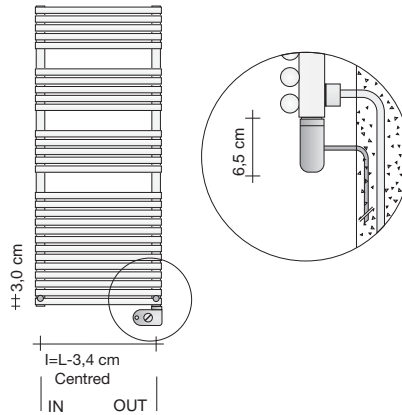

Mixed with Kit, Room thermostat and External Connectors

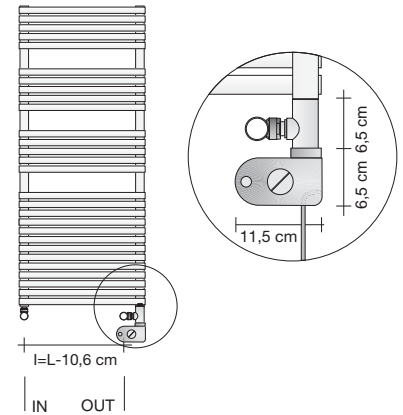

ADDITIONAL CHARGES FOR COLOURS AND FINISHES (see the official Tubes Colour Chart)

For RAL colours not included in the colour chart and according to samples request feasibility and estimate.

PLATED finishes: Nickel Satin finish (NIS code) NOT available, 14kt GOLD finish (cat. G5)+50% and 24kt GOLD (cat. G6)+60% more than Chrome (Cat.G0).

Standard VALVES (for Valves and Lockshields, valves that can be fitted with thermostat, Thermostatic valves, or Single pipe, Twin pipe, Stainless steel and thermostatic heads see pages 217 - 218 - 219 - 220)

	code	Description	Price
	Z1TLNR#ANR129010	Valve and Lockshield - ValCOLOR Copper Angle 1/2" RAL 9010 Glossy Pure White	€
	Z1RAC#R12CRO	2 copper unions diam. 12 mm for ValCOLOR Chrome finish Valve+Lockshield	€
	ZRCF#	Kit with pipe collars for towel warmers	€

	code	Description	Price
	GVR#	Valve and Lockshield assembly for recessed remote connection, CHROME finish	€
	GVRC#	Valve and Lockshield assembly for recessed remote connection, COLOUR finish	€

The electric version is made with a standard type resistor, the version with the new terminal will be available as of June 2014 with an additional price.

ELECTRIC VERSION

Code	H (cm)	L (cm)	Electric resistor Watts	Chrome plated G0 * (€)	Category C0 RAL 9010 (€)	Category C1/C2 (€)	Category C3 (€)
BA15KE#070040	73,0	40,0	300				
BA15KE#070050		50,0	300				
BA15KE#070060		60,0	600				
BA15KE#120040	113,0	40,0	600				
BA15KE#120050		50,0	600				
BA15KE#120060		60,0	900				
BA15KE#150040	153,0	40,0	600				
BA15KE#150050		50,0	900				
BA15KE#150060		60,0	900				
BA15KE#190040	193,0	40,0	900				
BA15KE#190050		50,0	900				
BA15KE#190060		60,0	1200				

* Additional charge for the new galvanic finishings Black Nichel and Tin Glossy +10% on the Chrome version. The same additional charge is valid for the valves too.

MIXED VERSION

Code	H (cm)	L (cm)	Inter-axis (cm)	Electric resistor Watts	Coloured version		Chrome plated version		Chrome plated G0 * (€)	Category C0 RAL 9010 (€)	Category C1/C2 (€)	Category C3 (€)
					Watts ΔT 50°C	Watts ΔT 30°C	Watts ΔT 50°C	Watts ΔT 30°C				
BA15KM#070040	73,0	40,0	29,4	300	350	186	237	126				
BA15KM#070050		50,0	39,4	300	455	244	296	159				
BA15KM#070060		60,0	49,4	600	562	305	355	193				
BA15KM#120040	113,0	40,0	29,4	600	516	276	348	186				
BA15KM#120050		50,0	39,4	600	657	354	435	234				
BA15KM#120060		60,0	49,4	900	800	435	522	284				
BA15KM#150040	153,0	40,0	29,4	600	712	380	454	242				
BA15KM#150050		50,0	39,4	900	893	480	567	305				
BA15KM#150060		60,0	49,4	900	1077	582	681	368				
BA15KM#190040	193,0	40,0	29,4	900	859	457	570	304				
BA15KM#190050		50,0	39,4	900	1074	579	712	384				
BA15KM#190060		60,0	49,4	1200	1294	707	855	467				

* Additional charge for the new galvanic finishings Black Nichel and Tin Glossy +10% on the Chrome version. The same additional charge is valid for the valves too.

WIRELESS THERMOSTATS

Code	Description	Price (€)
ZRF004	Kit with wall type room thermostat (Wireless) + Receiver	
ZRF005	Portable, digital wireless chronothermostat kit with weekly programming + Receiver	

CODES/ PRICES TABLE FOR ELECTRIC AND MIXED VERSION RESISTORS

Model	300 W			600 W			900 W			1200 W		
	Resistor code For Electric	Resistor code For Mixed	Price (€)	Resistor code For Electric	Resistor code For Mixed	Price (€)	Resistor code For Electric	Resistor code For Mixed	Price (€)	Resistor code For Electric	Resistor code For Mixed	Price (€)
Standard (STD) White cord	A2	KA2		B2	KB2		C2	KC2		D2	KD2	
Standard (STD) Grey cord	G2	KG2		H2	KH2		I2	KI2		L2	KL2	
Room thermostat - White	A5	KA5		B5	KB5		C5	KC5		D5	KD5	
Room thermostat - Grey	A7	KA7		B7	KB7		C7	KC7		D7	KD7	
Radiator Thermostat - White	N1	N.D.		N2	N.D.		N3	N.D.		N4	N.D.	
Radiator Thermostat - Chrome	N5	N.D.		N6	N.D.		N7	N.D.		N8	N.D.	
White edge cap	U1	KU1		U2	KU2		U3	KU3		U4	KU4	
Grey edge cap	V1	KV1		V2	KV2		V3	KV3		V4	KV4	
Chrome edge cap	Z1	KZ1		Z2	KZ2		Z3	KZ3		Z4	KZ4	

Wireless connections

How to carry out connection to the Electric supply with the new terminal



Wireless room thermostat
ZRF004



Portable, digital wireless chronothermostat
ZRF005

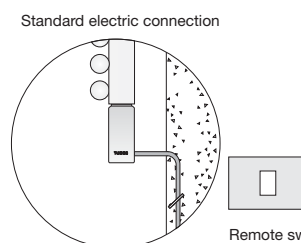
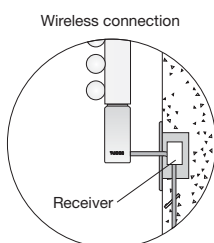

Remote switch (not supplied)

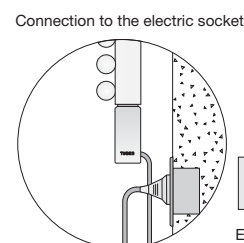

Electric plug not supplied